

ARC/HRC/ERC Standard 4-Row Ball Bearing Linear Guide
 WRC Wide 4-Row Ball Bearing Linear Guide
 ARR/HRR/LRR Standard 4-Row Roller-type Linear Guide

* cpc reserves the right to revise any information(technical details) any time without notice, for printing mistakes or any other incidental mistakes. We take no responsibility.

cpc CHIEFTEK PRECISION Co., LTD.

HEADQUARTERS
CHIEFTEK PRECISION Co., Ltd.
 No.3, Daji^{1st} Rd., Sinshih Township,
 Tainan Science Park, 741-45 Tainan, Taiwan, R.O.C
 TEL:+886-6-505 3858 Http://www.chieftek.com
 E-mail:service@mail.chieftek.com

CHIEFTEK PRECISION USA
 2280 E. Locust Court,
 Ontario, CA 91761, USA
 Tel:+1-909-773-1200
 Fax:+1-909-773-1202

cpc Europa GmbH
 Industriepark 314,
 D-78244 Gottmadingen, Germany
 TEL:+49-7731-59130-38
 FAX:+49-7731-59130-28

CHIEFTEK MACHINERY KUNSHAN Co., Ltd.
 No.1188, Hongqiao Rd, Kunshan,
 Jiangsu, P. R. China
 TEL:+86-512-5525 2831
 FAX:+86-512-5525 2851



Contents

ARC/HRC/ERC Standard 4-Row Ball Bearing Linear Guide

ARC/HRC/ERC Product Overview.....	P01~P02
Product design (Standard equipment).....	P03~P04
Product Design (Optional accessories).....	P07~P10
Technical Information.....	P11~P23
Installation instructions.....	P24~P27
Lubrication.....	P28
Accuracy.....	P29
Ordering Information.....	P30
Dimensions specification.....	P31~P43

WRC Wide 4-Row Ball Bearing Linear Guide

Ordering Information.....	P44
Dimensions specification.....	P45~P46

ARR/HRR/LRR 4-Row Roller-type Linear Guide

Product design.....	P47~P48
Ordering Information.....	P48
Dimensions specification.....	P49~P56

Grease Nipple Option

Grease Nipple Option.....	P57~P58
Lubrication Kit and Grease Gun.....	P59~P60

Lubrication Storages Pad Testing Report

Lubrication Storages Pad Test Report.....	P61
Linear Guide Service Life Calculation and Model Selection.....	P62

Selection method

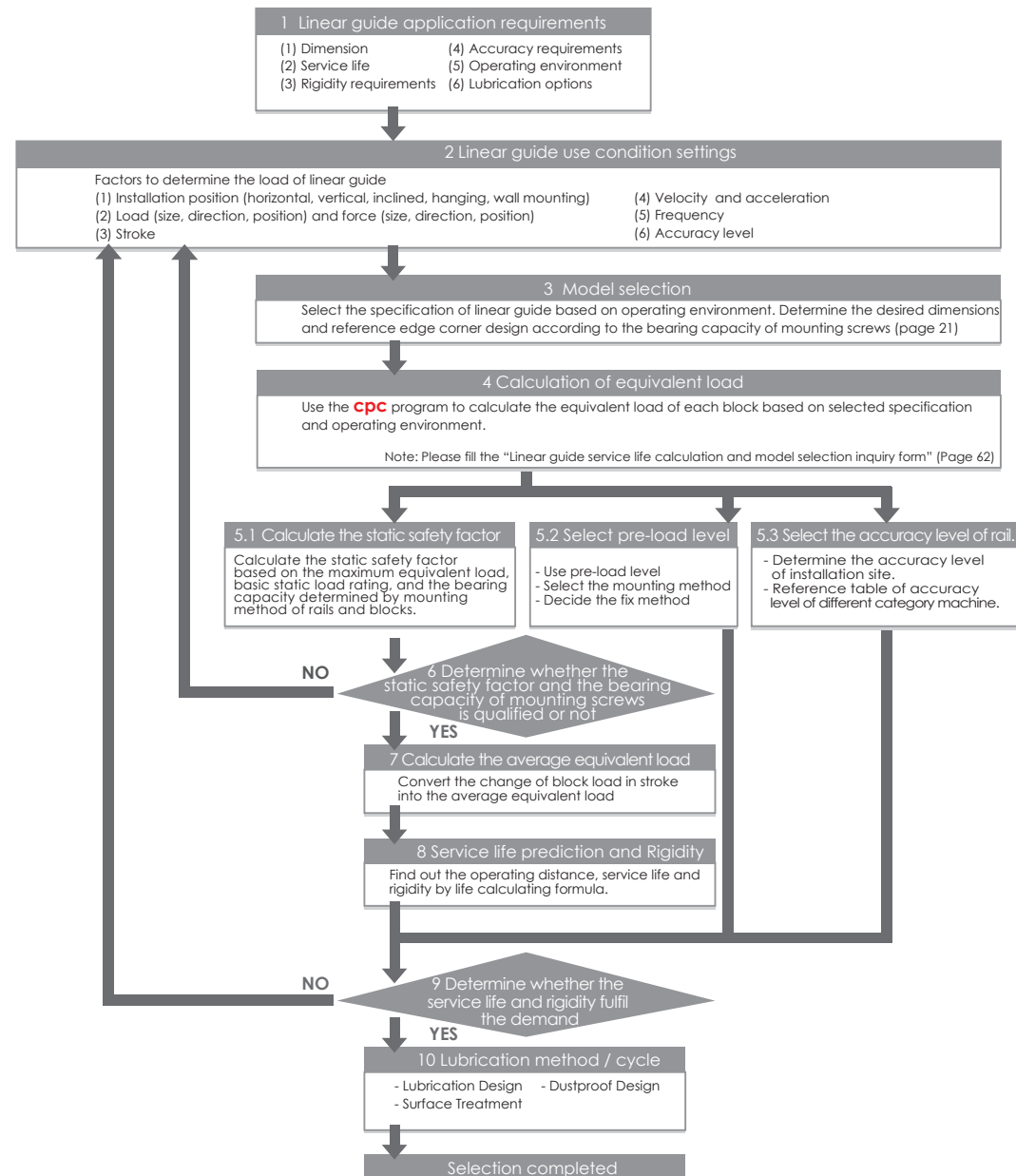

Product Overview

ARC/HRC/ERC Product Characteristics

Our standard **cpc** ARC/HRC/ERC Linear Guide Series uses the O-type arrangement for its four-row ball circulation design. The 45-degree contact angle between the rails and balls allows our product to realize a four-directional equivalent load effect. **cpc** has placed special emphasis on strengthening the arm length (Lo) of our product so that when sustaining external force (F), this can have an even higher Mr value, which increases its rigidity and torsion-resistant capabilities. The larger and more numerous balls in our products allows it to have a 10-30% greater load capacity than similarly sized competitor products. These and other characteristics are the source of our product's high load capacity, moment, and stiffness features.

Mode Code	Lo	Hc
15	12.4	9.35
20	16.4	12.5
25	19.5	14.5
30	24.0	17
35	30.4	19.5
45	38.2	24
55	43.1	28.5

Unit:mm

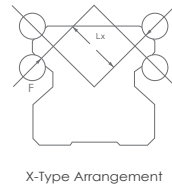
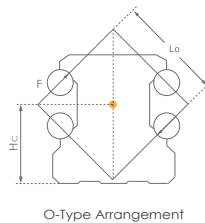

$$F = Mr/Lo (Lx)$$

Stainless steel reinforcement plate

- Total scraping of external objects above 0.3mm
- Increased X-axis axial force capacity

Inner Lubrication storage Pad (Upper)

- No need to increase the length of the runner block
- Full lubrication contact with balls, particularly suitable for short stroke movement.

End Cap

- All-around lubrication holes system

High abrasion resistant material end seal

- Standard contactless, low friction, high dust proof seal

Inner Lubrication storage Pad (Bottom)

Ball chain

- Patented design to enable reverse operations.
- Muted and prolonged service life

- High Load and torque capabilities

- Excellent dynamic performance: Reach Vmax 10 m/s Reach Qmax 450 m/s²

- Can provide counterbored holes from the top and tapped mounting holes from the bottom rail

- Can provide specialized steel surface treatment

Product Design

(Standard)

Dustproof design

Inner Seals

The newly designed inner seals both protect the rails from foreign particles and keep the lubrication inside the runner block, while maintaining a low friction profile.

Bottom Seals

The bottom seals work in conjunction with the inner seals to keep foreign particles out and lubrication from leaking out. Our comprehensive sealing design significantly reduces re-lubrication needs and prolongs service life of the runner block.

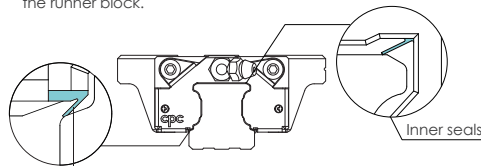

Bottom Seals

End Seals

The end seals work in conjunction with the bottom and inner seals to block foreign particles out and prevent lubrication leakage. Our engineering plastic has a strong friction resistance and is less prone to cracking than typical NBR plastics.

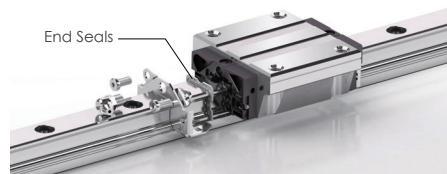

End Seals

Standard Seals (S)

Our standard seals are in direct contact with the rail surface, giving them increased dustproof and lubrication retention capabilities. **cpc** recommends this class of seal for blocks that operate in environments high in foreign particles, such as sawdust, for long periods of time. S-type seals will have a comparatively higher friction than B-Type seals.

Low Friction Seals (B)

Our low-friction seals have slight contact with the rail and are suitable for most environments, with both low friction and a scraper function.

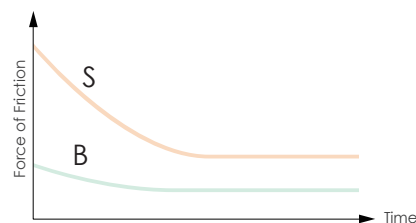
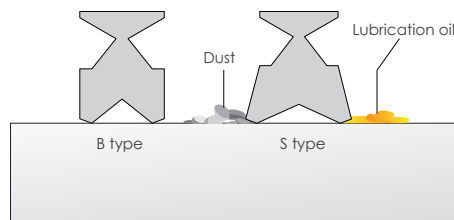

Seal type friction comparison

Friction levels will be the highest on new linear rails. But, after short periods of operation, such friction will be reduced to a constant level.

Stainless Steel Reinforcement Plate

The reinforcement plate also functions as a scraper for larger particulates like iron fillings, and has no more than 0.3mm clearance between the plate and the rail.

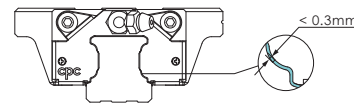

Average Friction of Block

Below are the tables for the block body and end seal friction levels under greaseless conditions.

Unit : N

Block Type	ARC/HRC/ERC							
	Friction caused from ball bearing				Bottom Seals + Inner Seals	End Seals (2 sides)		External NBR seal with metal scraper
	Preload Class					S-Type Standard	B-Type Low friction	
VC	V0	V1	V2					
15MN/FN	0.30	0.65	0.85	1.10	1.5	2.0	0.5	4
20MN/FN	0.40	0.75	1.40	1.60	2.0	2.5	1.0	5
25MN/FN	0.60	0.95	1.60	1.95	2.5	3.0	1.5	8
30MN/FN	0.55	1.10	2.00	3.10	3.0	5.0	2.0	10
35MN/FN	0.65	1.25	2.50	3.25	3.0	8.0	3.0	12
45MN/FN	0.85	2.10	2.80	4.00	4.0	11.0	4.0	20
55MN/FN	1.6	4.1	5.5	7.95	2.0	13.0	-	-

Unit : N

Block Type	ARC/HRC/ERC							
	Friction caused from ball bearing				Bottom Seals + Inner Seals	End Seals (2 sides)		External NBR seal with metal scraper
	Preload Class					S-Type Standard	B-Type Low friction	
VC	V0	V1	V2					
15MS/FS	0.30	0.60	0.80	1.00	1.5	2.0	0.5	4
20MS/FS	0.40	0.70	1.10	1.40	2.0	2.5	1.0	5
25MS/FS	0.50	0.90	1.20	1.80	2.5	3.0	1.5	8
30MS/FS	0.50	1.00	1.80	2.30	3.0	5.0	2.0	10

Unit : N

Block Type	ARC/HRC/ERC							
	Friction caused from ball bearing				Bottom Seals + Inner Seals	End Seals (2 sides)		External NBR seal with metal scraper
	Preload Class					S-Type Standard	B-Type Low friction	
VC	V0	V1	V2					
15ML/FL	0.40	0.70	0.90	1.40	1.5	2.0	0.5	4
20ML/FL	0.50	0.80	1.60	1.80	2.0	2.5	1.0	5
25ML/FL	0.70	1.20	1.80	2.00	2.5	3.0	1.5	8
30ML/FL	0.80	1.40	2.20	2.80	3.0	5.0	2.0	10
35ML/FL	0.90	1.60	2.70	3.50	3.0	8.0	3.0	12
45ML/FL	1.00	2.30	3.50	4.55	4.0	11.0	4.0	20
55ML/FL	1.9	4.3	6.6	8.6	2.0	13.0	-	-

Applied example

- ARC25MN SZ V1N
Block friction = $1.3+2.5+3 = 6.8\text{N}$
- HRC30FL BZ V0P
Block friction = $1.4+3+2 = 6.4\text{N}$

Friction caused from ball bearing
Bottom Seals + Inner Seals
+) End Seals (2 sides)
Block friction

Product Design

(Standard)

Saw wood dust Test

Test content

This test uses a total of 4 groups of products (2 rails matched with 2 lubrication methods) which are put on a saw wood dust surface on which a back and forth motion test is performed.

Rail

1. Tapped from top rail plus hole plugs (AR)
2. Tapped from bottom rail (ARU)

Runner Block

1. Installation of standard contact type seals (S), using grease
2. Installation of lubrication storage Pad and standard contact type seals (SZ), using grease

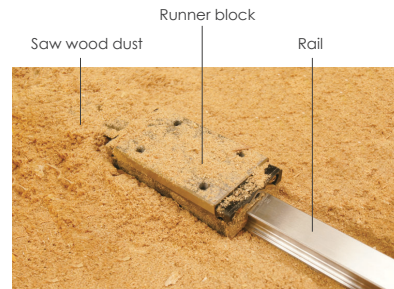

Testing conditions

1. Stroke = 600mm
2. Total testing stroke = 30m

Test items

1. If saw wood dust enters the inner surface of the runner block
2. If saw wood dust enters the ball bearing runner area

Test results

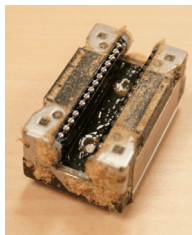
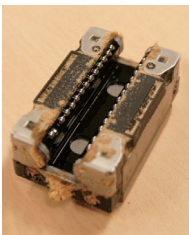

Tapped from bottom (oil) Tapped from bottom (grease)

Checked Item	If saw wood dust enters inner block surface	If saw wood dust enters ball bearing runner area
Installation status		
ARU Rail SZ Type Runner Block (oil lubrication)	No	No
ARU Rail S Type Runner Block (grease lubrication)	No	No
AR Rail SZ Type Runner Block (oil lubrication)	Yes (belly area)	No
AR Rail S Type Runner Block (grease lubrication)	Yes (belly area)	No

Test result

- The tapped from top rail has hole plugs, leading to rail unevenness, allowing some saw wood dust to enter the runner block belly area. The 2 sides of the runner block belly area are completely protected by stainless steel reinforcement plates and end seals, meaning that the ball bearing runner area is fully shielded from saw wood dust.
- The tapped from bottom rail has an even rail surface so that the ball bearing runner area is fully protected from saw wood dust.

Stainless steel reinforcement plate (Patent)

Scraping function on both sides

Using 2 stainless steel reinforcement plates, the L type design allows for screws to be fastened onto the top and bottom of the runner block, reinforcing the rigidity and cladding of its caps.

The clearance between the rail profile with the seal design is below 0.3mm, reinforcing the steel plates while enabling scraper functions.

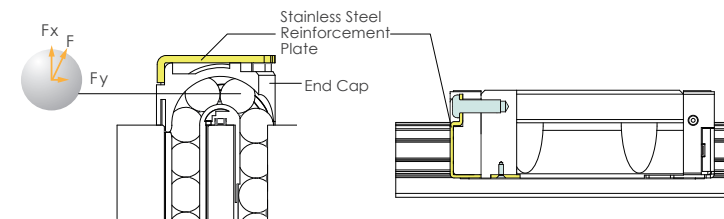

Function of high speed operation

Our ARC/HRC/ERC type features stainless steel reinforcement plates and additional bottom latches, increasing its axial force and tolerance capacity to achieve faster operation speeds.

$V_{max} > 10 \text{ m/s}$ $Q_{max} > 450 \text{ m/s}^2$

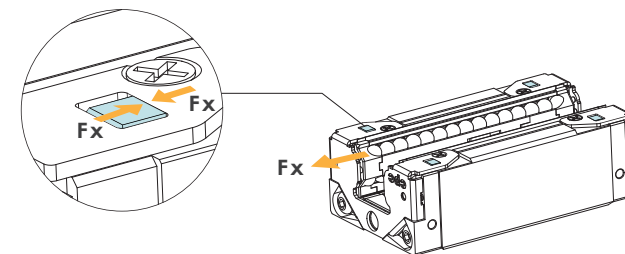

Multi-Directional Lubrication Nozzles (All-direction Lubrication Nozzles)

Our product features lubrication ports on the top, bottom, and sides, allowing installation of optional grease nipples for relubrication. The top port comes with a O-ring seal to allow easy re-lubrication from the top, and our diverse comprehensive lubrication injection design allows for lubrication in both axis.



Product Design (Option)

Low noise, superior quality high speed ball chain (Patent)

Ordering code: C

With traditional ball type linear guides, the spinning of balls in different directions leads to a two times faster contact speed. Such high friction greatly reduce the service life of such products. Additionally, the contact point between such balls also produces high pressure and noise levels while increasing the danger of oil film cladding damage.

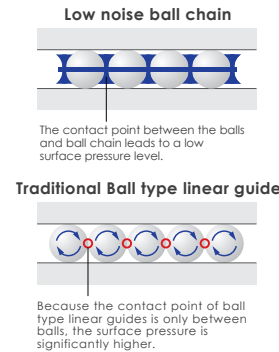
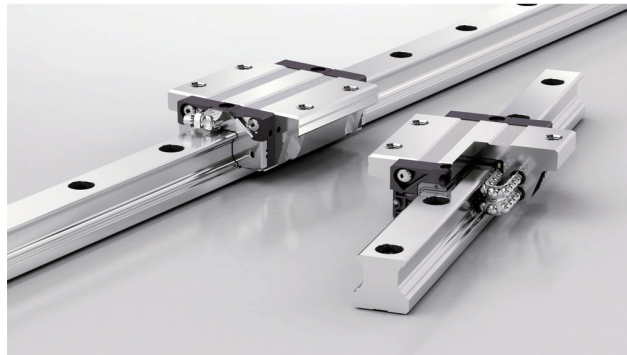

* The **cpc** ball chain provides a greater contact area between the balls and the ball chain. Because the film cladding will not be damaged easily and due to the lower noise volume, balls can move at a higher speed while product service life can also be extended significantly.

* The size of the ball chain design block is the same as that of linear guides without ball chains, allowing for same dimensions and use of identical guides.

Heavy load test

Condition
 Model : ARC25MN SZC V1H Dynamic load rating C_{100} : 24.8kN
 Velocity : 1m/sec Stroke : 960mm
 Load capacities : 7.44kN(0.3C) Preload : 0.05C

$$\text{Rating Life} \left(\frac{C}{P} \right)^3 \times 100\text{km} = \left(\frac{C}{0.05C + 0.3C} \right)^3 \times 100\text{km} = 2332\text{km}$$

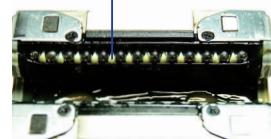
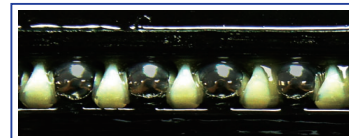

After testing, grease remains without anomalies.

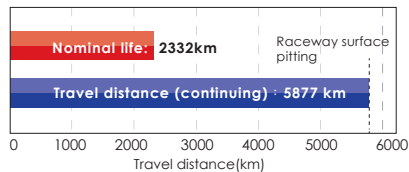

Smoothness test

Model code : ARC25MNSV1N
 Velocity : 10 mm/sec

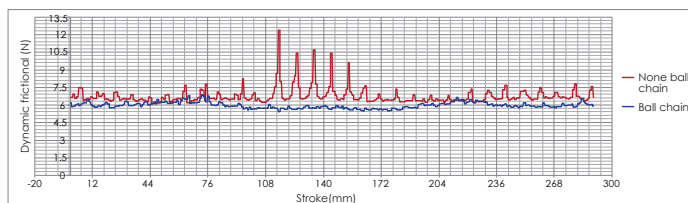

Load capacity of ball chain

There are three advantages of ARC/HRC/ERC ball chain series as compared with traditional, non-ball chain blocks :

1. The space block in the ball chain can prevent the oil film from rupturing by ball to ball contact and decrease friction induced wear.
2. The retainer block of the ball chain can maintain a reliable oil film layer by continuously applying grease on the moving part.
3. The ball chain provides the important function of leading steel ball motion. For traditional blocks without ball chains, its steel balls are pushed by the rotating back steel balls on the raceway, meaning that the contact angle between the balls and rail is less precise, causing vibration and an increased stress level between balls. In comparison, the balls in our ball chain product are led by the ball chain to ensure a correct fit and accurate contact angles. In this way, our product's ball chain design ensures that it can fit correctly when entering the raceway and that the contact angle will be accurate. This means that our Ball chain design provides for a smooth performance, lower vibration levels and less additional stress levels. Subsequently increase the dynamic load rating, C_{cage} value.

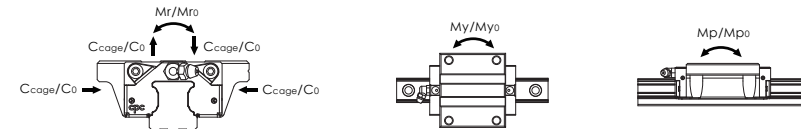

Dynamic rating load

The table on the right shows the C_{cage} and C_{iso} values via different machine type testing. (According to ISO-14728 regulations)

Model Code	C_{iso} (kN)	C_{cage} (kN)
ARC-MN C	15	9.4
ARC-FN C	20	15.4
HRC-MN C	25	22.4
HRC-FN C	30	31.0
ERC-MN C	35	43.7
	45	67.6
ARC-ML C	15	12.5
HRC-ML C	20	18.9
HRC-FL C	25	28.5
ERC-ML C	30	38.0
	35	50.6
	45	86.2
ARC-MS C	15	7.1
ARC-FS C	20	11.6
ERC-MS C	25	16.8
	30	21.3

Static rating load & Static torque

The C type block of ARC/HRC/ERC will increase the pitch between balls on the operating profile. Therefore, the static rating load C_0 and the static rating torque M_{r0} , M_{p0} and M_{y0} values will be decreased.

Model Code	Static rating load(kN)		Static torque(Nm)		
	C_0	M_{r0}	M_{p0}	M_{y0}	
ARC-MN C	15	16.2	130	95	95
ARC-FN C	20	25.7	275	200	200
HRC-MN C	25	36.4	465	340	340
HRC-FN C	30	49.6	780	530	530
ERC-MN C	35	70.2	1575	1010	1010
	45	102.8	2955	1775	1775
ARC-ML C	15	24.3	195	215	215
HRC-ML C	20	34.3	370	350	350
HRC-FL C	25	51.6	655	640	640
ERC-ML C	30	66.1	1040	900	900
	35	94.7	1940	1575	1575
	45	159.7	4185	3280	3280
ARC-MS C	15	10.8	85	45	45
ARC-FS C	20	17.1	185	85	85
ERC-MS C	25	24.3	310	145	145
	30	28.9	455	205	205

Product Design (option)

Lubrication Design (Ordering Code: Z) (ARC/HRC/ERC)

Inner oil storage and oil supply system design

Our Inner PU Lubrication Storage Pad design does not increase the length of the runner block and can effectively lubricate all balls. Customers can inject lubrication oil directly through its lubrication holes to ensure a sufficient storage in the PU Lubrication storage pad. This not only enables long term lubrication effects, but also a higher degree of ease at conforming to environment protection needs and lowering maintenance costs. For short stroke movements, this product allows for highly effective lubrication.

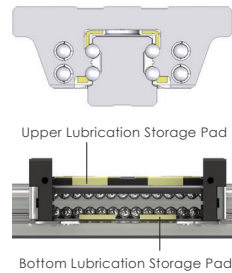

External NBR Seal with Metal Scraper (Ordering Code: SN / HN) (ARC/HRC/ERC/ARR/HRR/LRR)

Available for applications in harsh environments such as in grinding, glass processing, graphite processing and wood-working machinery, providing a highly effective dust and iron scrap proofing solution

SN: (made by BRB) For application in harsh environment.

HN: (made by HNBR) For application of resisting acidic / basic coolant.

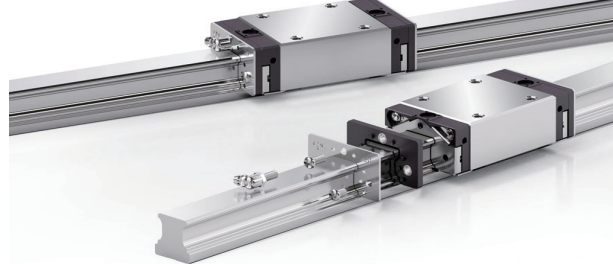

Dimensions and Specifications

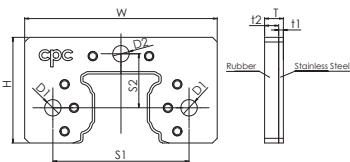

Unit: mm

Model Code	Exterior Dimension					Bore Specification				Screw Specification			
	T	t1	t2	W	H	S1	S2	D1	D2	N1	N2	Ln	
Ball	15	4	1	3	33	20.3	25	10.2	3.5	3.5	M3x0.35	M3x0.5	9
	20	4	1	3	41	22.5	29	11.5	3.5	3.5	M3x0.35	M3x0.5	9
	25	5.2	1.2	4	47	26.5	36.5	13.5	3.5	6.5	M3x0.35	M6x0.75	12
	30	6	1.5	4.5	58	34.2	42.5	17.5	4.5	6.5	M4x0.5	M6x0.75	12
	35	6	1.5	4.5	68	39.3	50	20.5	4.5	6.5	M4x0.5	M6x0.75	12
	45	6	1.5	4.5	84	49.6	65	24.9	4.5	10	M4x0.5	PT1/8	15
Roller	55	6	1.5	4.5	98	57	73	28	5.5	6.5	M5x0.5	M6x0.75	12
	35	6	1.5	4.5	69	37.6	60	20	4.5	6.5	M4x0.5	M6x0.75	16
45	6	1.5	4.5	84.9	43.5	70	22.9	4.5	6.5	M4x0.5	M6x0.75	16	

Installation Manual

- When installing the external NBR seal, please ensure that the block is on the rail
- Ensure that the rubber part is fitted in the sleeve. If the rubber part has fallen off, set the sleeve to the corresponding bore.
- Overlap the rubber part and metal scraper with the corresponding salient point and bore. The **cpc** logo must be facing outward.
- Slide the external NBR seal into the rail from two sides and closely connect with the block.
- Fasten the screw into the correspondence bore and align the seal with the center of the rail and properly fastened. Do not allow the metal scraper to make contact with the guide rail.

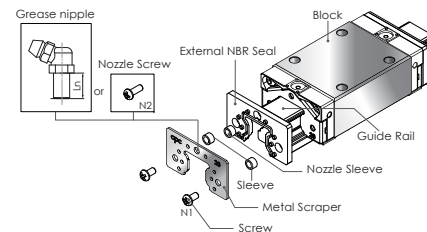

Metal-Plastic-Cap Patent Design for Standard Rail-Bolt-Hole (With patent) (Ordering Code: MPC)

Metal Cap Features Introduction

The Most Convenient Metal Cap Used in Industry

- The upper part of the cap is made of stainless steel which can prevent sharp foreign objects from piling up on the bolt-hole and affect the end seal function.
- The lower part of the cap is made of plastic, and can be installed directly on a standard rail without the need for additional bolt-hole slot milling.
- The bolt-hole chamfer for standard rails is C0.2mm. For further dustproof requests, the non-bolt-hole chamfer rail is optional upon ordering. (order code: TR)

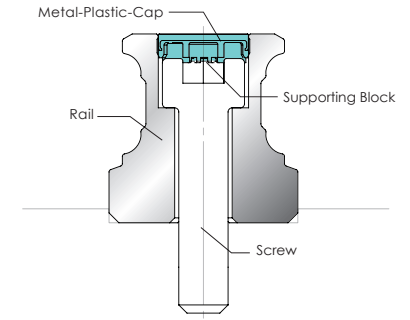
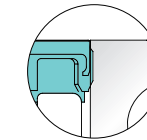
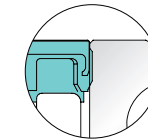

Cap can be Smoothly Installed on Bolt-Hole

Bolt-hole cap of conventional linear guides, due to the difficulty of controlling hammering strength, often result in caps being hammered too deep or surface unevenness which leads to the accumulation of dirt or scrap iron. Our **cpc** cap is especially designed with a supporting block to prop up the cap and to fix the screw stably, thus preventing such unnecessary sinking.

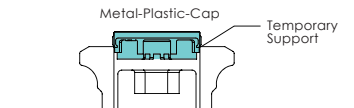

Dimensions and Specifications

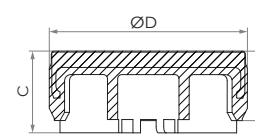

Model Code	Screw	External Diameter D	Cup Height H	Block Height C	Rail
A4	M4	7.7	1.7	2.0	AR15, WRC21/15, WRC27/20
A5	M5	9.7	3.4	4.0	AR20
A6	M6	11.3	2.9	3.5	AR25
A8	M8	14.3	3.9	4.5	AR30, AR35
A12	M12	20.4	5.0	5.6	AR45/ARR45
A8-R	M8	14.3	8.0	9.5	ARR35
A14	M14	24.4	6.0	6.5	AR55

Technical Information

Load capacity and service life

Basic static load capacity C_0

The static load along the direction of the force; under this static load, the maximum calculated stress at the center point of the contact surface between the ball and the track:

The value is 4200 MPa when radius of curvature ratio = 0.52

The value is 4600MPa when the radius of curvature = 0.6

Roller and rail contact surface produces the maximum calculated stress:
The value is 4000MPa

Note: At this point of maximum stress contact will yield a permanent deformation, which corresponds to 0.0001 diameter of the rolling element. (Above according to ISO 14728-2)

Static load safety factor calculation

- (1) $S_0 = C_0 / P_0$
- (2) $S_0 = M_0 / M$
- (3) $P_0 = F_{max}$
- (4) $M_0 = M_{max}$

Operating situation	S_0
General operation	1~2
Shock or impact	2~3
High precision and smooth operation	≥ 3

Equivalent static load P_0 and basic static torque M_0

The application of the static load capacity of the linear guide series must be considered:

- Static load of linear guide
- Allowable load of screw fixation
- Permissible load of connected bodies
- The required static load safety factor for the application

The equivalent static load and static torque are the maximum load and torque values, refer to equations (3) and (4).

Static load safety factor S_0

In order to be able to withstand the permanent deformation of the linear bearing and ensure that it will not affect the accuracy and smooth operation of the linear slide system. The static load safety factor S_0 is calculated as equations (1) and (2).

- S_0 Static load safety factor
- C_0 Basic static load N in direction of load
- P_0 Equivalent static load N in direction of load
- M_0 Basic static torque Nm in direction of load
- M Equivalent static torque Nm in direction of load

When the block alone experiences the torque

If the block alone experiences the torque from M_p and M_y direction, the maximum allowable torque for the block to run smoothly is 0.2 to 0.3 times static torque. And the block with larger preload would have larger maximum allowable torque and vice versa. When static torque M_p and M_y is larger than maximum allowable torque, the jumping of the block will be caused when the ball is rolling through the loaded / unloaded region in the block. If you have above mentioned design problem, please contact our technical department.

Basic dynamic load capacity C_{iso} (general design) / C_{cage} (ball chain design)

$$C_{iso} : C_{100} / C_{50}$$

Definition: C_{100} is a radial load with constant magnitude and direction; when the linear bearing is subjected to this load, its rated life can theoretically reach a walking distance of 100 kilometers, and C_{50} is a walking distance of 50 kilometers. (Above according to ISO 14728-1)

According to ISO 14728-1 for the bearing steel used in the current technology, the calculated life span of 90% survival rate for a single or batch of sufficient and identical linear bearings under normal manufacturing quality and normal operating conditions is as follows:

$$(5) \quad L = \left[\frac{C_{100}}{P} \right]^{\alpha} \cdot 10^5$$

$$L = \left[\frac{C_{50}}{P} \right]^{\alpha} \cdot 5 \times 10^4$$

L = rated life

C_{100}/C_{50} = Dynamic Load Rating (N)

P = equivalent load (N)

When using a ball type linear guide $\alpha = 3$

When using roller linear guide $\alpha = \frac{10}{3}$

Please refer to equations (6) and (7) for a comparison of the basic rated load capacity defined by the two types of basic load capacity conversion when the standard rated load capacity C_{50} is taken as the standard when the 50 km distance is taken as the rated life. (according to ISO14728-1)

Ball

$$(6) \quad C_{50} = 1.26 \cdot C_{100}$$

$$(7) \quad C_{100} = 0.79 \cdot C_{50}$$

C_{cage} is a basic dynamic load capacity value of block with ball chain, which is 120 to 130% of the C_{iso} value according to the practical test (see Page 8). Formulas (5), (6), and (7) also apply to $C_{100/cage}$ and $C_{50/cage}$

According to the operating velocity and frequency, the service distance can be converted to service life, assuming the equivalent load and average velocity are constant.

$$(8) \quad L_h = \frac{L}{2 \cdot s \cdot n \cdot 60} = \frac{L}{v_m \cdot 60}$$

L_h = Rated life (h)

L = Rated life for walking 100 km (m)

s = Single stroke (m)

n = Frequency of reciprocating stroke (min^{-1})

v_m = Average velocity (m/min)

Technical Information

Load capacity and life

Equivalent load and Velocity

When the load and velocity are not constant, all actual loads and velocities must be considered, and it will impact the service life.

For each segment of each block, when the load changes, the equivalent load is calculated according to formula (9).

$$(9) \quad P = \alpha \sqrt{\frac{q_1 \cdot F_1^\alpha + q_2 \cdot F_2^\alpha + \dots + q_n \cdot F_n^\alpha}{100}}$$

P = equivalent load (N)

When using ball-type linear guide $\alpha = 3$

When using roller-type linear guide $\alpha = \frac{10}{3}$

q = portion of working distance per segment (%)

F_i = load per segment (N)

When the velocity changes, the equivalent velocity is calculated according to formula (10).

$$(10) \quad \bar{v} = \frac{q_1 \cdot v_1 + q_2 \cdot v_2 + \dots + q_n \cdot v_n}{100}$$

\bar{v} = equivalent velocity (m/min)

q = portion of working distance per segment (%)

When the load and velocity all change, the equivalent load is calculated according to formula (11).

$$(11) \quad P = \alpha \sqrt{\frac{q_1 \cdot v_1 \cdot F_1^\alpha + q_2 \cdot v_2 \cdot F_2^\alpha + \dots + q_n \cdot v_n \cdot F_n^\alpha}{100 \bar{v}}}$$

P = equivalent load (N)

When using ball-type linear guide $\alpha = 3$

When using roller-type linear guide $\alpha = \frac{10}{3}$

q = percentage of walking distance per segment (%)

v = velocity of each segment (m/min)

F_i = load per segment (N)

When the linear guide is subjected to any angular load and the direction of the force other than the horizontal or vertical direction, the approximated value of equivalent load is calculated as (12).

$$(12) \quad P = |F_x| + |F_y|$$

P = equivalent load (N)

F_x = force at horizontal component (N)

F_y = force at vertical component (N)

When the linear guide experience both load and torque at the time, the approximated value of equivalent load is calculated by formula (13)

$$(13) \quad P = |F| + |M| \cdot \frac{C_0}{M_0}$$

P = equivalent load (N)

F = load applied to the LM guide (N)

M = static torque (Nm)

C₀ = basic static load direction (N)

M₀ = basic static torque in direction of force (Nm)

In general, the loads on the linear guide exert on the four major planes. However it can be the load from any angle.

In this case, the life of the linear guide is reduced. This can be interpreted by the flow of forces inside the system.

Line chart

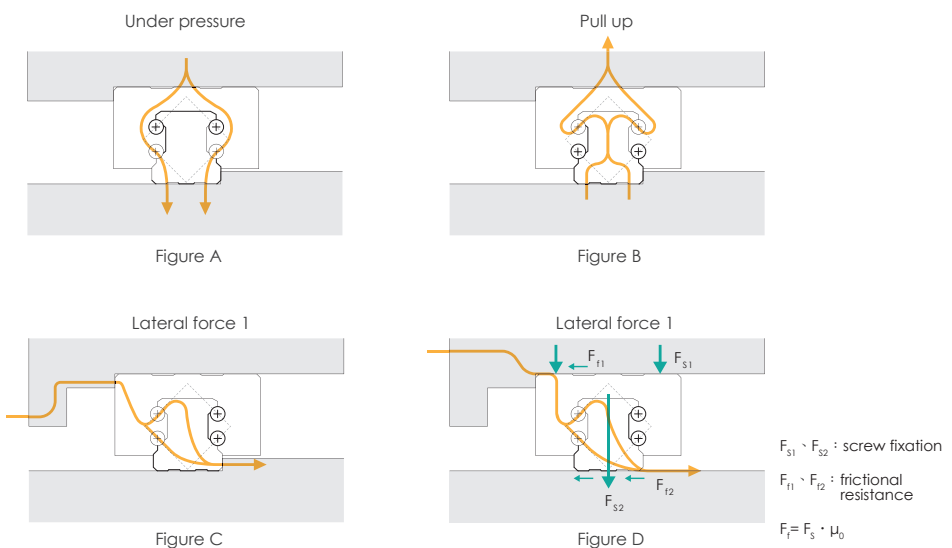

As can be seen from the three diagrams in Figure A to Figure D, when subjected to upward, downward and lateral loads, the force flow will be distributed to the two ball transfer.

Technical Information

Load capacity and life

Line chart

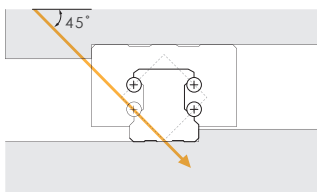

Figure E

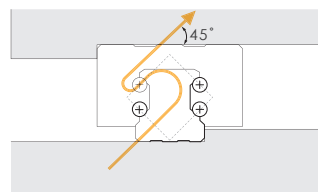

Figure F

As shown in the two diagrams in Figures E and F, the load acting on the 45-degree angle has the greatest effect on the system's life because the transfer of force is limited to a single row of balls.

When the load is applied horizontally or vertically (0°, 90°, 180°, 270°), the equivalent load of the slide is equal to the actual load. When the load angle is 45°, its equivalent load is approximately 1.414 times that of the main direction. (as shown in formula (12))

When the same load is at different angles, the comparison of equation (12) and the actual equivalence load is as shown in the following figure.

Therefore, in order to increase the service life of the linear system, it should be installed in the appropriate direction to bear the load. Otherwise, the service life will be greatly reduced, as shown in the figure below. Since the relationship between life and load is as the power of formula (5), when the acceptance angle is 45°, the service life will be significantly reduced.

The following is the life L comparison chart (in %) for different angles under the same load.

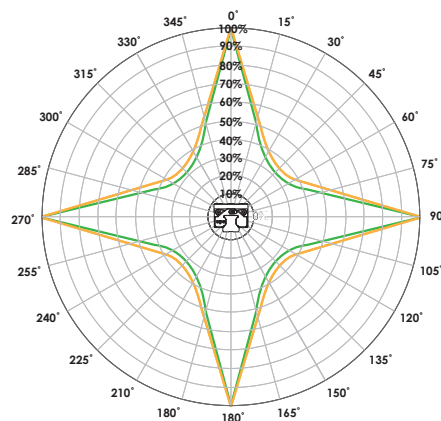
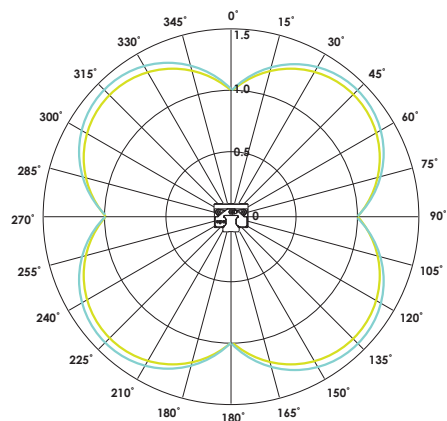

— Equation (12) (Page 13) calculates the approximate value of the equivalent load — Actual equivalence load

— Ball — Roller

The following is a comparison diagram of the equivalent load approximate value and the actual equivalent load calculated by Equation (13). The example uses the ARC25MN linear guide to withstand a fixed down pressure and the torque gradually increases. The above figure shows the torque in the M_r direction. The figure below shows the torque in the $M_{p/y}$ direction.

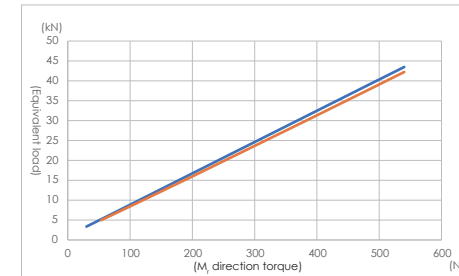

— Equation (13) (Page 14) Calculate the approximate value of the equivalent load $| \frac{M_r}{M_{ro}} | \cdot C_o$
— Actual equivalence load

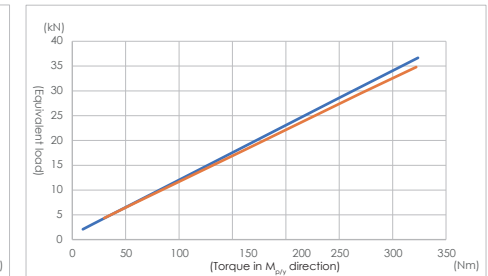

— Equation (13) (Page 14) calculates the approximate value of the equivalent load $| \frac{M_{p/y}}{M_{p/y0}} | \cdot C_o$
— Actual equivalence load

Load calculation

1. The load exert on the linear guide would varies due to the position of object's center of gravity, thrust position and acceleration / deceleration induced inertia.
2. Because of the uneven distribution of force on linear guide, when a certain part of rail, or when a force exertion point is damaged, the linear guide system would start to malfunction.
3. The point with largest force exertion must be identified, and be used reference to calculate the equivalent load, to ensure the reliability of service life calculation.

Ball

$$Q \propto F (Dw^{\frac{1}{2}}, \delta^{\frac{3}{2}}, C_g^{\frac{3}{2}})$$

Q = load
 δ = amount of rolling element deformation
 Dw = ball diameter
 C_g = geometric constant

Roller

$$Q \propto F (\delta^{\alpha}, \ell_{eff}^{\beta})$$

Q = load
 δ = amount of rolling element deformation
 ℓ_{eff} = contact length
 $\alpha > 1.1$
 $\beta > 0.7$

As shown by the formula, the relationship between the amount of deformation of the rolling element and load is not linear. A larger deformation will cause the non-linear increase of load.

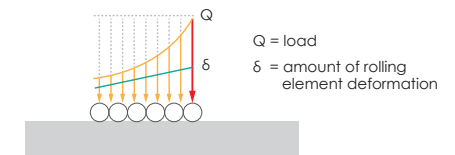

Therefore by using the **cpc** self-developed program, the "Loading, Lifetime, & Rigidity Analysis Software of Linear Guide System (LLRAS)", a precise service life estimation can be derived. This is done by optimum calculation of deformation and rotation when a linear guide experience load, in this case the accurate equivalent load can be calculated.

Technical Information

Loading, Lifetime, & Rigidity Analysis Software of Linear Guide System (LLRAS) Data input guidance

1. Set the slide rail position, the number of slides on the slide

Rail1	Rail2
Rail Y coordinate	0 200
Rail Z coordinate	0 0
Rotation angle	0 0
Number of Block	2 2

Base coordinates:
 X axis: Movement direction on the horizontal plane
 Y axis: The direction of the vertical X axis on the horizontal plane
 Z axis: Vertical horizontal direction

System coordinates:
 X axis: Direction of movement
 Y axis: Span direction
 Z axis: Vertical platform orientation

Variables can be set:
 - Linear guide span
 - Linear guide height
 - Linear guide placement angle
 - Platform inclination
 - Number of block

2. Set the carriage size model

Rail number	Rail1	Rail1	Rail2	Rail2
Block number	Block1	Block2	Block1	Block2
Block X coordinate	0	200	0	200
Block category	ARC	ARC	ARC	ARC
Size	25	25	25	25
Model code	ARC25MN	ARC25MN	ARC25MN	ARC25
Preload value	VC	VC	VC	VC

Class	Description	Preload Value	1	2	3	4	5
VC	Clearance	0	+0~+0	+0~+0	+0~+0	+0~+0	+0~+0
VO	Light Preload	0.00C	+0~+4	+0~+4	+0~+4	+0~+7	+0~+10
V1	Medium Preload	0.00C	+4~+12	+4~+14	+4~+14	+7~+19	+8~+28
V2	Heavy Preload	0.10C	+11~+19	+14~+23	+14~+23	+22~+38	+28~+44

Variables can be set:
 - Block span
 - Block type
 - Block preload

3. Set the exercise state

First movement interval	Second exercise interval	The third sports section
Acceleration interval V & a	Constant speed interval V & S	Deceleration interval V & a
Known information		
Final speed V (m/s)	1	0
Acceleration a (m/s ²)	2	-2
Exercise time (s)	0.500	0.500
Travel S (mm)	250.000	250.000

Drive position Y coordinate (mm): 100
 Drive position Z coordinate (mm): 0
 Acting frequency (1/min): 20
 Daily operating hours (hr): 24

Variables can be set:
 - Working status
 - Drive position
 - Actuation frequency

4. Set external force and torque position, size, direction

Coordinate	First external force or torque
X coordinate (mm)	100
Y coordinate (mm)	100
Z coordinate (mm)	100
Force in the X direction (N)	0
Force in the Y direction (N)	0
Force in the Z direction (N)	500
X-axis torque (N-m)	0
Y-axis torque (N-m)	0
Z-axis torque (N-m)	0

Check the force and torque included in each zone:
 Section1: First external force (torque)
 Section2: First external force (torque)
 Section3: First external force (torque)

Variables can be set:
 - External force (torque) intensity
 - External force (torque) position
 - External force (torque) working zone

Technical Information

Loading, Lifetime, & Rigidity Analysis Software of Linear Guide System (LLRAS)

5. Set the quality position size

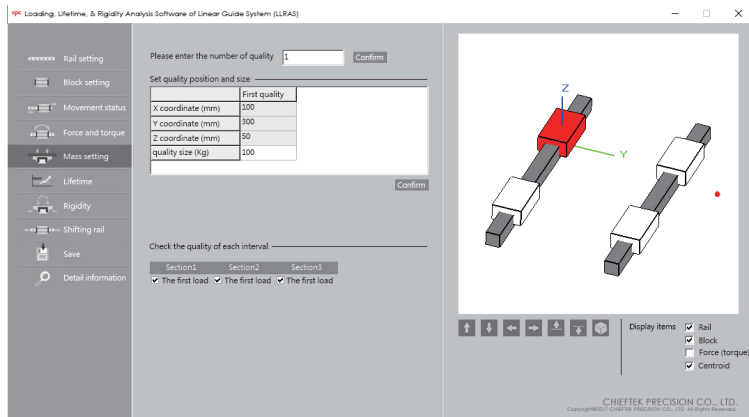

Variables can be set:
 - Center of gravity position
 - Center of gravity dimension
 - Load range

6. Check if the settings are correct from the 3D chart

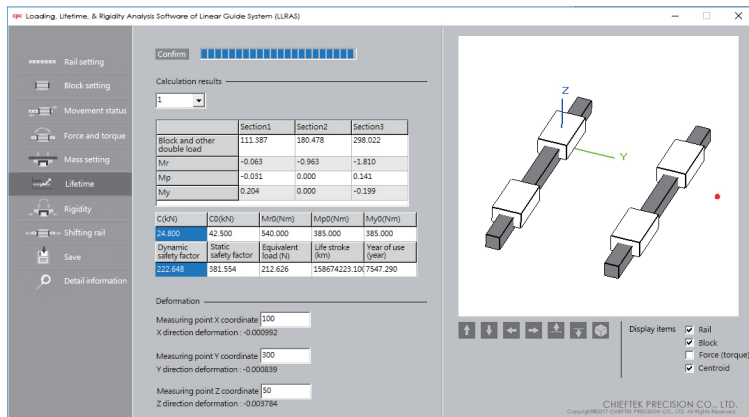

The calculation results are shown in the figure, and the information such as force and equivalent load, safety factor, and life span of each section can be obtained, and the deformation of any measured point can also be obtained.*

This program can be used to calculate the installation and dimension design of various linear slide rails under different load and movement conditions. The obtained information such as deformation amount, force distribution, and life span can help to provide appropriate and correct design recommendations.

* For the calculation of amount of deformation, only the rolling object is considered. For actual deformation the steel body of block must be considered as well. When the load > 20% C0, the actual deformation is 1.5 times larger than calculated deformation. When Load = C0, the actual deformation is 2~2.5 times of calculated deformation.

Application Example

Using the ARC 25 MN VC block, the schematic diagram of the mechanism is as follows:

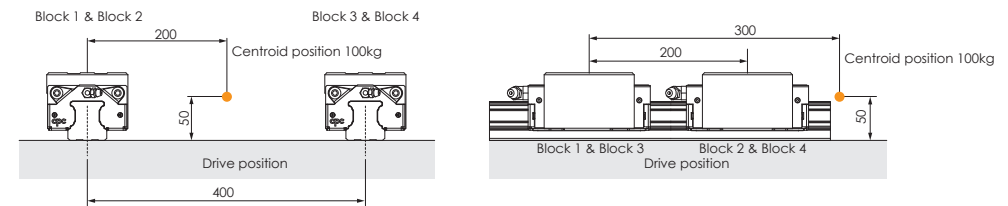

Motion status is as follows

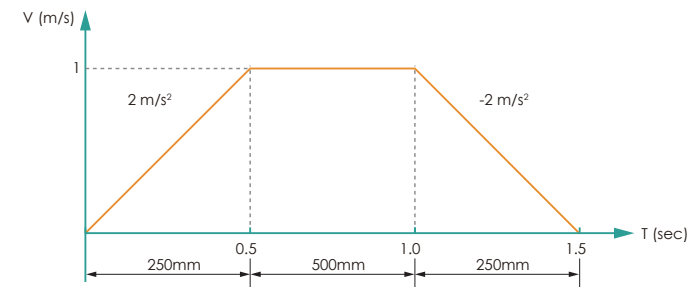

cpc Unit:N

	Block 1	Block 2	Block 3	Block 4
At acceleration	348.6	914.5	348.6	914.5
At constant velocity	384.0	949.9	384.0	949.9
At deceleration	419.4	985.3	419.4	985.3
Average load	385.9	951.0	385.9	951.0

Traditional calculated results obtained by geometric distribution. Unit:N

	Block 1	Block 2	Block 3	Block 4
At acceleration	220	711	220	711
At constant velocity	245	736	245	736
At deceleration	270	761	270	761
The maximum value of average load	736			

Results calculated by program

In this case, the calculated result of equivalent load is 30% higher than result obtained by traditional geometric distribution method, and the service life is about 2 times different.

If there is a demand for life and rigidity calculation, please fill in form of [Linear guide service life calculation and model selection] and contact **cpc** technical department.

Technical Information

The maximum bearing capacity of linear guide is not only related to the static load capacity C_0 , but also the screw mounting of coupling parts. Factors such as length of block, distance between rails, size of screws, and contact width of rail would impact the maximum bearing capacity of screw mounting.

Screw tightening torque (Nm)

Strength grade 12.9 Alloy steel screws	steel		cast iron	Non-ferrous metals
	M3	M4	M5	M6
M3	2.0	1.3	1.0	
M4	4.1	2.7	2.1	
M5	8.8	5.9	4.4	
M6	13.7	9.2	6.9	
M8	30	20	15	
M10	68	45	33	
M12	118	78	59	
M14	157	105	78	

The lateral bearing capacity (without support from edge and lateral mounting)

Linear guide often experience lateral load when used; in the case of mounting screw only, the lateral bearing capacity is suggested to be determined by the static friction force resulted from the screw tightening torque. If the maximum lateral load is exceeded, the support from the edge, lateral mounting and plugs are possible options to enhance the load capacity.

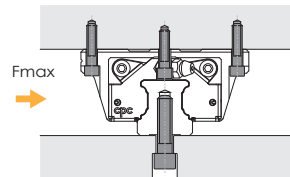

According to DIN637, DIN SIO 12090-1 and DIN EN ISO 898-1 regulation, when the tensile strength, torque and lateral force exert on class 8.8 alloy steel screw is larger than the values in table below, the screw mounting and design of edge support must be revised to avoid loose.

Screw maximum tensile strength and torque

size	ball type						roller type			
	short		standard		long		standard		long	
	$F_{z,max}$ N	$M_{1,max}$ Nm	$F_{z,max}$ N	$M_{1,max}$ Nm	$F_{z,max}$ N	$M_{1,max}$ Nm	$F_{z,max}$ N	$M_{1,max}$ Nm	$F_{z,max}$ N	$M_{1,max}$ Nm
15	3200	22	3700	26	4200	30	-	-	-	-
20	5500	51	6400	60	7300	68	-	-	-	-
25	8100	87	9400	100	10800	120	-	-	-	-
30	15900	210	18500	240	21100	280	-	-	-	-
35	-	-	18500	300	21100	340	36900	590	42200	680
45	-	-	45900	970	52400	1100	91700	1900	104800	2200
55	-	-	63700	1600	72800	1800	-	-	-	-

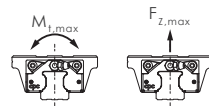

Screw lateral bearing capacity

size	ball type			roller type	
	short	standard	long	standard	long
	$F_{y,max}$ N	$F_{y,max}$ N	$F_{y,max}$ N	$F_{y,max}$ N	$F_{y,max}$ N
15	240	280	320	-	-
20	410	480	550	-	-
25	610	710	810	-	-
30	1200	1400	1600	-	-
35	-	1400	1600	2800	3200
45	-	3400	3900	6900	7900
55	-	4800	5500	-	-

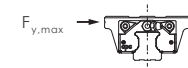

When class 10.9 class alloy steel screw is used, the value is about 1.4 times larger than the value in table above. When 12.9 class alloy steel screw is used, the value is about 1.68 times larger.

Lateral bearing surfaces and lateral fixing elements

When the lateral load is greater than the lateral load capacity, the lateral bearing surface is required to bear the lateral force. If the lateral force is bidirectional, Lateral fixing elements can be used to provide a bidirectional lateral load capability of the linear guide on the other side of the side bearing surface, and help close to the lateral bearing surface, the lateral straightness and side load capacity after installation will be greatly improved, and its allowable value will vary according to the type of fixed component.

The following diagram shows several common elements.

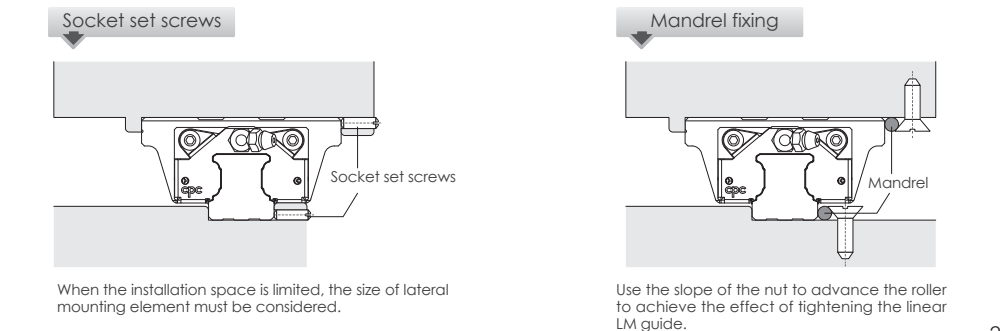
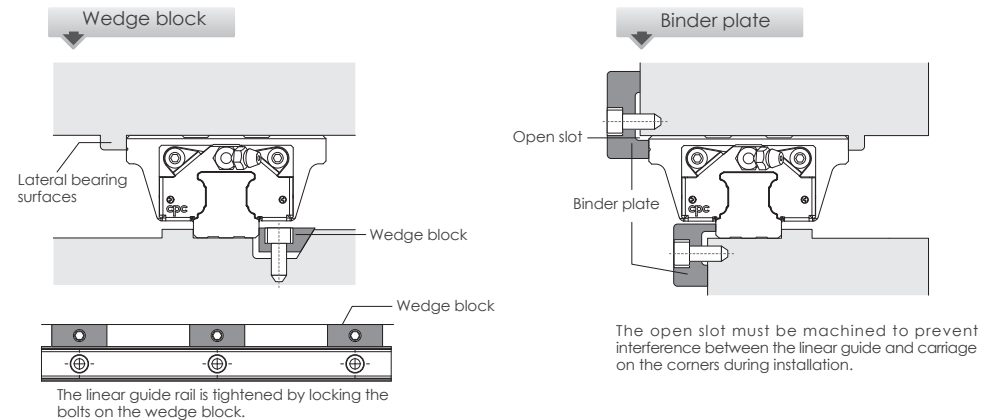

Technical information

Preload and clearance

The ARC/HRC/ERC linear guides provide 4 different preload classes VC, V0, V1, V2.

Class	Description	Preload Value	ARC/WRC							Application
			Clearance (μm)							
			15 WRC21/15	20 WRC27/20	25	30	35	45	55	
VC	Clearance	0	+5~+0	+5~+0	+5~+0	+5~+0	+5~+0	+5~+0	+5~+0	Smooth motion, low friction
V0	Light Preload	0.02C	+0~-4	+0~-5	+0~-6	+0~-7	+0~-8	+0~-10	+0~-12	For precision situations, smooth motion
V1	Medium Preload	0.05C	-4~-10	-5~-12	-6~-15	-7~-18	-8~-20	-10~-24	-12~-28	High stiffness, precision, high load situations
V2	Heavy Preload	0.08C	-10~-16	-12~-18	-15~-23	-18~-27	-20~-31	-24~-36	-28~-45	Super high stiffness, precision and load capacity

Class	Description	Preload Value	HRC/ERC							Application
			Clearance (μm)							
			15	20	25	30	35	45	55	
VC	Clearance	0	+5~+0	+5~+0	+5~+0	+5~+0	+5~+0	+5~+0	+5~+0	Smooth motion, low friction
V0	Light Preload	0.02C	+0~-4	+0~-5	+0~-6	+0~-7	+0~-8	+0~-10	+0~-12	For precision situations, smooth motion
V1	Medium Preload	0.08C	-4~-12	-5~-14	-6~-16	-7~-19	-8~-22	-10~-25	-12~-29	High stiffness, precision, high load situations
V2	Heavy Preload	0.13C	-11~-19	-14~-23	-16~-26	-19~-31	-22~-35	-25~-40	-29~-46	Super high stiffness, precision and load capacity

Installation Notice

Dimension of reference edge

To ensure that the linear guide is precisely assembled with the machine table, **cpc** devices have a recess installed in the reference edge corner. The corner of the machine table must be smaller than the chamfer of the linear guide to avoid interference. To consult on chamfer sizes and shoulder heights, please refer to the table below.

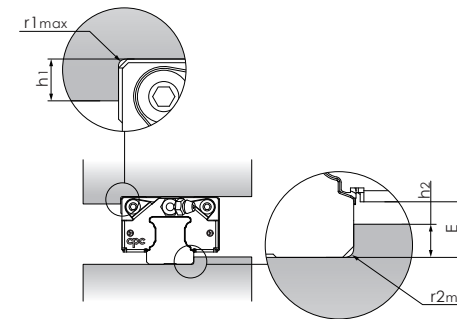

Unit : mm

ARC/HRC/ERC					
Type	r1max	r2max	h1	h2	E
15	0.5	0.5	4.0	2.5	3.3
20	0.5	0.5	5.0	4.0	5.0
25	1.0	1.0	5.0	5.0	6.0
30	1.0	1.0	6.0	5.5	6.6
35	1.0	1.0	6.0	6.5	7.6
45	1.0	1.0	8.0	8.0	9.3
55	1.5	1.5	10.0	10.0	12.0

WRC					
Type	r1max	r2max	h1	h2	E
21/15	0.4	0.4	5.0	2.0	2.7
27/20	0.4	0.4	5.0	3.0	3.5

ARR/HRR/LRR					
Type	r1max	r2max	h1	h2	E
35	1	1	8	5	6
45	1	0.5	10	7	8

Rail Joint

The standard length of our large rails is 4 meters. If longer rails are required, **cpc** can provide a joint rail solution for which the joint number will be marked on the rail.

- As shown in figure A, please follow the joint number to assemble.
- For more than two units in each axis, to avoid accuracy effects from multiple blocks passing through the same connection point, we advise to use the connection points separately as shown on figure B.
- Please use the slide as a connection point to tighten the slide before tightening the torques to fasten the screws from inside to outside.

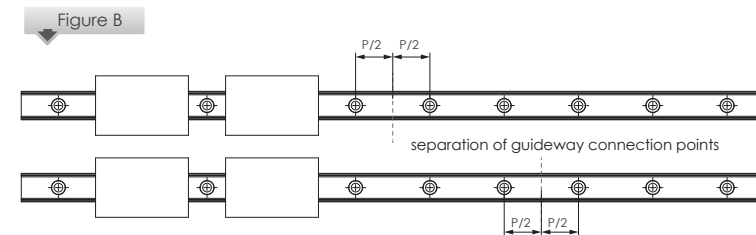

Installation instructions

Installation surface geometry position accuracy

The rough finishing or milling on installation site will impact the working accuracy of linear guide, and reduce the service life of both standard, wide ball type linear guide and roller type linear guide. The accuracy of installation site and linear guides are critical factors to determine the accuracy of work bench. When the error of installation site is larger than the value calculated by following formula, the working resistance and service life will be impacted.

$$e1 \text{ (mm)} = b \text{ (mm)} \cdot f1 \cdot 10^{-4}$$

$$e2 \text{ (mm)} = d \text{ (mm)} \cdot f2 \cdot 10^{-5}$$

$$e3 \text{ (mm)} = f3 \cdot 10^{-3}$$

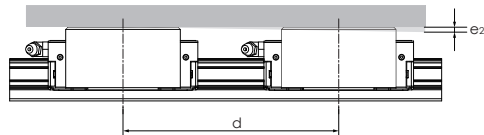
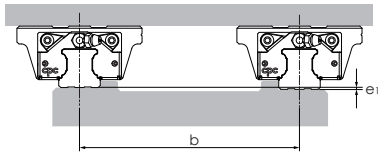

Installation datum plane

Rail: Both edges of rail can be reference edge, it shouldn't be marked separately.

Block: The side steel body of the block with
 1. milled surface
 2. Without groove mark can be the reference side.

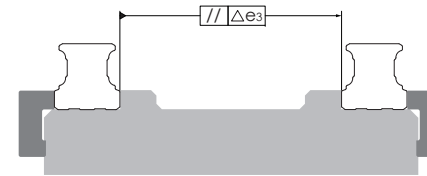

Applicable to 15-55 all models

ARC/HRC/ERC (f1)				
Block length	VC	V0	V1	V2
MS / FS	5.2	3.5	2.2	1.1
MN / FN	4.5	3.1	1.8	0.8
ML / FL	4.2	2.8	1.7	0.7

ARR/HRR/LRR (f1)				
Block length	VC	V0	V1	V2
MN / FN	1.3	1.1	1.0	0.8
ML / FL	1.2	1.1	0.9	0.7
MXL / FXL	1.2	1.0	0.9	0.7

ARC/HRC/ERC (f2)				
Block length	VC	V0	V1	V2
MS / FS	43.1	29.7	18.3	8.9
MN / FN	26.0	17.5	10.5	4.8
ML / FL	18.4	12.3	7.3	3.1

ARR/HRR/LRR (f2)				
Block length	VC	V0	V1	V2
MN / FN	7.1	6.2	5.2	4.3
ML / FL	5.3	4.7	3.9	3.2
MXL / FXL	4.2	3.6	3.0	2.5

ARC (f3)				
Block length	VC	V0	V1	V2
15 MS / FS	20	14	9	5
15 MN / FN	18	13	8	4
15 ML	16	12	7	3
20 MS / FS	25	18	12	6
20 MN / FN	23	16	10	5
20 ML	21	14	9	4
25 MS / FS	31	22	15	8
25 MN / FN	27	20	13	6
30 MS / FS	38	28	18	10
30 MN / FN	33	24	15	8
30 ML	31	22	14	7
35 MN / FN	37	27	17	8
35 ML	35	25	16	8
45 MN	49	35	23	11
45 ML	45	32	21	10
55 MN	65	46	30	15
55 ML	62	44	28	13

HRC / ERC (f3)				
Block length	VC	V0	V1	V2
15 MN / FN / FN-R	18	13	8	4
15 ML / ML-R / FL / FL-R	16	12	7	3
20 MN / FN / FN-R	23	16	10	5
20 ML / ML-R / FL / FL-R	21	14	9	4
25 MS	31	22	15	8
25 MN / FN / FN-R	27	20	13	6
25 ML / ML-R / FL / FL-R	25	18	11	5
30 MN / FN / FN-R	33	24	15	8
30 ML / ML-R / FL / FL-R	31	22	14	7
35 MN / FN / FN-R	37	27	17	8
35 ML / ML-R / FL / FL-R	35	25	16	8
45 MN / FN / FN-R	49	35	23	11
45 ML / ML-R / FL / FL-R	45	32	21	10
55 MN / FN / FN-R	65	46	30	15
55 ML / ML-R / FL	62	44	28	13

ARR/HRR/LRR (f3)				
Block length	VC	V0	V1	V2
35 MN / FN	11	9	6	3
35 ML / FL	10	8	5	2
35 MXL / FXL	10	7	5	2
45 MN / FN	14	11	7	4
45 ML / FL	13	10	7	3
45 MXL / FXL	12	10	6	3

Installation instructions

Rail installation

Diagram	Description	Feature
	<ul style="list-style-type: none"> No Straightening Not allowed 	No precision Low lateral bearing capacity
	<ul style="list-style-type: none"> Straightening by pin Not suggested 	Low precision Low lateral bearing capacity
	<ul style="list-style-type: none"> Straightening based on straight edge, calibrated by meter 	Low to mid precision Low lateral bearing capacity
	<ul style="list-style-type: none"> Place the rail on a supporting edge (Precision vise applied) 	High precision One side with high lateral bearing capacity
	<ul style="list-style-type: none"> With support edge and lateral mounting screw 	Very high precision High lateral bearing capacity on both sides.

Recommended precision measurement method

The working accuracy of linear guide is defined by the parallelism between block and rail (height, side). In practical application the linear accuracy is required, the measuring method is diverse, so we would suggest following measure to acquire the linear accuracy of linear guide.

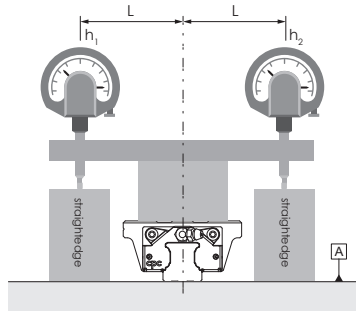

H The horizontal working accuracy \parallel/P +
 base plane flatness $\square/A = |h_1 - h_2|_{\text{total length}}$
 (above mentioned method can be used to exclude the skew error of rail on roll direction)

* When the error of flatness of base plane is 0, the value is the linear working accuracy of rail at the certain height
 (Please refer to table of working precision page 29)

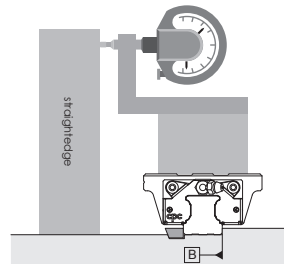

W₂ The horizontal working accuracy \parallel/P +
 the straightness of rail installation \square/B

* When the error of the straightness of the rail is 0, the value is the horizontal working accuracy on the side.
 (Please refer to table of working precision page 29)

Lubrication

Function

The loaded rolling elements and the raceway will be separated at the contact zone by a micron-thick layer of oil. The lubrication will therefore

- reduce friction
- reduce wear
- reduce oxidation
- dissipate heat and increase service life

Lubrication caution

- The blocks contain grease, can it can be directly installed on the machine, no need to be washed.
- If the block is washed, please do not soak the block into lubrication oil until the cleaning detergent and the cleaning naphtha is totally dry. Soak the block into the lubrication oil until the oil-pad is full of lubricant, then the block is ready for installation.
- The linear guide must be lubricated for protection purpose before first-use, this is to avoid the contact with pollutant.
- The **cpc** block has grease inlet at front end, back end, left side, right side and top. The lubricant can be injected through the grease inlet. Please see the table below for the amount of grease needed for different block model.
- Please ensure the block is moving back and forth when the grease is injected into the block.
- Frequent visual inspection is necessary to ensure the rail is constantly protected by a layer of oil.
- The re-lubrication process must be done before the discoloration due to oil exhaustion
- Please notify when the block is used in acidic, alkaline, or clean room applications.
- Please contact our technical department for lubrication assistance if the rail mounting is different from horizontal direction.
- The re-lubrication interval must be shortened if the travel stroke is <2 or >15 times the length of steel body of block.

The amount of oil needed to fulfill single block.

Size	ARC/HRC/ERC		
	short (S)	standard (N)	long (L)
15	1.4	2	3.2
20	2.3	4	5.5
25	3.9	7	9.5
30	5.9	10	14
35	-	16	21
45	-	32	40
55	-	53	66.5

Size	WRC		WRC (ball chain type)	
	standard (N)		Size	standard (N)
21/15	2.7		21/15	2.2
27/20	5.3		27/20	4.8

Size	ARR/HRR/LRR		
	standard (N)	long (L)	extra long (XL)
35	9.4	11.0	14.1
45	22	26.4	30.8

Size	ARC/HRC/ERC (ball chain type)		
	short (S)	standard (N)	long (L)
15	1.2	1.5	2.5
20	2.3	3.5	5
25	3.9	7	9
30	5.4	9	12.5
35	-	15	19.5
45	-	30	37
55	-	-	-

Size	ARR/HRR/LRR (roller chain type)		
	standard (N)	long (L)	extra long (XL)
35	8.8	9.7	12.4
45	20.8	24.3	27.7

Technical information

Accuracy

The ARC/HRC/ERC/WRC linear guides provide 5 different grades of precision : N, H, P, SP, and UP, Engineers can choose different grades depending on the machine applications.

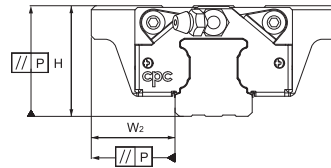

Accuracy

Size	Accuracy grades (μm)		UP	SP	P	H	N
15 ~ 20	Tolerance of dimension height H	H	± 5	± 10	± 15	± 30	± 70
	Variation of height for different runner blocks on the same position of Rail	Δ H	3	5	6	10	20
	Tolerance of dimension width W ₂	W ₂	± 5	± 7	± 10	± 20	± 40
	Variation of width for different runner blocks on the same position of Rail	Δ W ₂	3	5	7	15	30
25 ~ 35	Tolerance of dimension height H	H	± 5	± 10	± 20	± 40	± 80
	Variation of height for different runner blocks on the same position of Rail	Δ H	3	5	7	15	20
	Tolerance of dimension width W ₂	W ₂	± 5	± 7	± 10	± 20	± 40
	Variation of width for different runner blocks on the same position of Rail	Δ W ₂	3	5	7	15	30
45 ~ 55	Tolerance of dimension height H	H	± 5	± 10	± 20	± 40	± 80
	Variation of height for different runner blocks on the same position of Rail	Δ H	3	5	7	15	25
	Tolerance of dimension width W ₂	W ₂	± 5	± 7	± 10	± 20	± 40
	Variation of width for different runner blocks on the same position of Rail	Δ W ₂	3	5	7	15	30

Runner block relative to linear guide, datum plane parallel motion precision

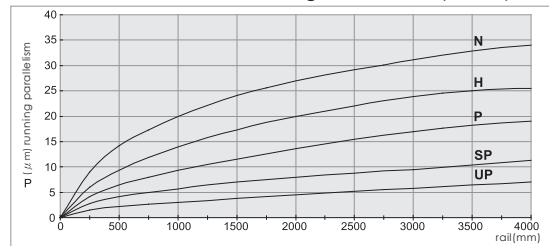

Application

class	Movement, Conveyance	Manufacturing Equipment	High Precision Manufacturing Equipment	Measuring Equipment
N	●	●		
H	●	●	●	
P		●	●	●
SP			●	●
UP				●
Examples	1. Conveyance system 2. Industrial robots 3. Office Machinery	1. Woodworking machine 2. Punching press 3. Injection Molding machine	1. Lathe/milling machine/ grinding machine 2. Electrical discharge machining (EDM) 3. CNC machining center	1. Three dimensional measuring instrument 2. Detection mirror / head shaft 3. X-Y Table

Ordering information

ARC	U	15	M	N	-R	B	2	Z	C	V1	P	-1480L	-20	-20	II	/J	
Customization code																	
Number of rails on the same moving axis																	
End hole pitch (mm)*																	
Starting hole pitch (mm)*																	
Rail length (mm)																	
Accuracy grade : UP, SP, P, H, N																	
Preload class : VC, V0, V1, V2																	
C: with ball chain (Available for size 15,20,25,30,35 and 45)																	
Z: with lubrication storage pad																	
Block quantity																	
Seal type : B: Low friction S: Standard																	
R: six mounting holes Unlabeled: Standards																	
Block length : L: long N: standard S: short																	
Block width : M: standard F: flanged																	
Block type : 15, 20, 25, 30, 35, 45, 55																	
U: rail (tapped from the bottom)																	
Product type : ARC: automation series HRC/ERC: heavy load series																	

Customization code(The meaning of suffix characters)

J : slide rail connection	R : special process for rail	SG : installation of side grease holes and set screws
G : customer designated lubricant	VD : customized designated preload pressure value	PC : with plastic caps for counter holes on the rail
I : with inspection report	OA : block install with grease nipple by cpc (Please contact cpc for direction of grease nipple installation)	MPC : with Metal-Plastic Caps for rail mounting holes.
S : special straightness requirements for rail	DE : reference edges of block and rail on opposite sides	TR : bolt-Hole without chamfer
B : special processing for block	HN : external HNBR seal with metal scraper	
BL : with extension and contraction support layer.		
SN : external NBR seal with metal scraper		
BR : black chrome coating treatment on the rail	CR : clear chrome coating treatment on the rail	RR : raydent coating treatment on the rail
BB : black chrome coating treatment on the block	CB : clear chrome coating treatment on the block	RB : raydent coating treatment on the block
BRB : black chrome coating treatment on the block and rail	CRB : clear chrome coating treatment on the block and rail	RRB : raydent coating treatment on the block and rail
SB : with stainless steel ball bearings	NR : nickel coating treatment on the rail	NB : nickel coating treatment on the block
NRB : nickel coating treatment on the block and rail		

Note: For special process or customized requirement, please contact **cpc** for more information.

* The end pitch of the rail should not exceed the 1/2 of original pitch, this is to avoid the misfit of the rail to the workbench.

Dimensions Table

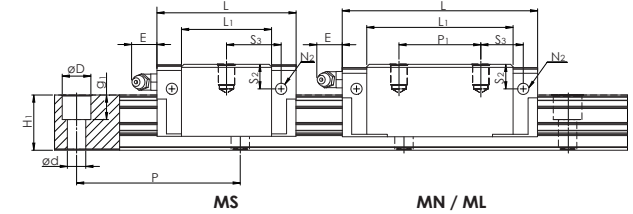
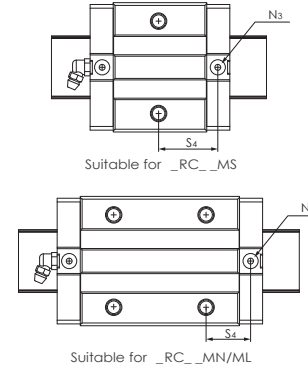
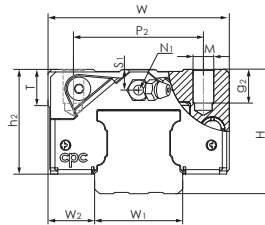

ARC MS Series

Model Code	Mounting Dimensions		Rail Dimensions(mm)			Block Dimensions(mm)													Load Capacities (kN)		Static Moment (Nm)			Weight		Model Code						
	H	W2	W1	H1	P	Dx dxg1	W	L	L1	h2	P1	P2	P3	Mxgx2	M1	T	N1	N2	N3	E	S1	S2	S3	S4	C		C0	Mr0	Mp0	My0	Block(g)	Rail(g/m)
ARC 15 MS	24	9.5	15	15	60	7.5x4.5x5.3	34	41.2	26	20.7	-	26	-	M4x7	-	6	M3x6.5	M3x6	P3	3.5	4.5	7.5	15.6	16.7	7.7	12.1	100	50	50	106	1290	ARC 15 MS
ARC 20 MS	28	11	20	20	60	9.5x6x8.5	42	49.2	32.2	23	-	32	-	M5x7	-	8	M3x7.5	M3x5.5	P4	10	4	7.4	19.1	19.8	12.5	19.3	205	100	100	170	2280	ARC 20 MS
ARC 25 MS	33	12.5	23	23	60	11x7x9	48	57.4	38.4	27	-	35	-	M6x9	-	8	M6x7.5	M3x6.5	P4	12	5	9.3	22.2	23.2	18.2	27.3	350	160	160	300	3020	ARC 25 MS
ARC 30 MS	42	16	28	27	80	14x9x12	60	68	44	35.2	-	40	-	M8x12	-	12	M6x8.5	M6x5	P5	12	7.5	12	27	26.7	23.3	33.1	520	230	230	560	4380	ARC 30 MS

ERC MS Series

ERC 25 MS	36	12.5	23	23	60	11x7x9	48	57.4	38.4	30	-	35	-	M6x9	-	12	M6x7.5	M3x6.5	P4	12	8	12.3	22.2	23.2	18.2	27.3	350	160	160	315	3020	ERC 25 MS
-----------	----	------	----	----	----	--------	----	------	------	----	---	----	---	------	---	----	--------	--------	----	----	---	------	------	------	------	------	-----	-----	-----	-----	------	-----------

ARC MN Series

ARC 15 MN	24	9.5	15	15	60	7.5x4.5x5.3	34	55.5	40.3	20.7	26	26	-	M4x7	-	6	M3x6.5	M3x6	P3	3.5	4.5	7.5	9.8	10.9	9.9	17.5	140	105	105	158	1290	ARC 15 MN
ARC 20 MN	28	11	20	20	60	9.5x6x8.5	42	69	52	23	32	32	-	M5x7	-	8	M3x7.5	M3x5.5	P4	10	4	7.4	13	13.7	17.1	30.0	325	230	230	266	2280	ARC 20 MN
ARC 25 MN	33	12.5	23	23	60	11x7x9	48	81.2	62.2	27	35	35	-	M6x9	-	8	M6x7.5	M3x6.5	P4	12	5	9.3	16.6	17.6	24.8	42.5	540	385	385	420	3020	ARC 25 MN
ARC 30 MN	42	16	28	27	80	14x9x12	60	95.5	71.5	35.2	40	40	-	M8x12	-	12	M6x8.5	M6x5	P5	12	7.5	12	20.8	20.5	32.8	53.7	845	565	565	800	4380	ARC 30 MN
ARC 35 MN	48	18	34	32	80	14x9x12	70	111.2	86.2	40.4	50	50	-	M8x13	-	14	M6x10	M6x7	P5	12	8	15	23.4	24.1	45.9	82.9	1700	1080	1080	1120	6790	ARC 35 MN
ARC 45 MN	60	20.5	45	39	105	20x14x17	86	135.5	102.5	50.7	60	60	-	M10x17	-	14	PT1/8x12.5	M6x10.5	P5	14	11.1	18.1	27.3	27.3	71.3	122.1	3200	1910	1910	2120	10530	ARC 45 MN
ARC 55 MN	70	23.5	53	45.7	120	24x16x20	100	168.5	126.5	58	75	75	-	M12x20	-	16	M6x10	M6x13	P5	12	13.5	23.5	34.8	33.8	128	186	4949	3278	3278	4200	14000	ARC 55 MN

ARC ML Series

ARC 15 ML	24	9.5	15	15	60	7.5x4.5x5.3	34	76.2	61	20.7	34	26	-	M4x7	-	6	M3x6.5	M3x6	P3	3.5	4.5	7.5	16.1	17.2	13.4	26.9	215	235	235	240	1290	ARC 15 ML
ARC 20 ML	28	11	20	20	60	9.5x6x8.5	42	87.2	70.2	23	45	32	-	M5x7	-	8	M3x7.5	M3x5.5	P4	10	4	7.4	15.6	16.3	20.4	38.5	415	390	390	330	2280	ARC 20 ML
ARC 30 ML	42	16	28	27	80	14x9x12	60	118	94	35.2	60	40	-	M8x12	-	12	M6x8.5	M6x5	P5	12	8.7	12	21.7	21.7	39.6	70.2	1105	950	950	1138	4380	ARC 30 ML
ARC 35 ML	48	18	34	32	80	14x9x12	70	136.6	111.6	40.4	72	50	-	M8x13	-	14	M6x10	M6x7	P5	12	8	15	25.1	25.8	54.7	106.5	2185	1755	1755	1536	6790	ARC 35 ML
ARC 45 ML	60	20.5	45	39	105	20x14x17	86	171.5	138.5	50.7	80	60	-	M10x17	-	14	PT1/8x12.5	M6x10.5	P5	14	11.1	18.1	35.3	35.3	89.5	169.1	4430	3460	3460	3160	10530	ARC 45 ML
ARC 55 ML	70	23.5	53	45.7	120	24x16x20	100	202	160	58	95	75	-	M12x20	-	16	M6x10	M6x13	P5	12	13.5	23.5	41.5	40.5	147	226	6472	5284	5284	5083	14000	ARC 55 ML

1. The load capacities is for full-ball type (without ball chain)
3. N3 = O-ring size for lubrication from above

2. N2 = Injecting holes
4. N2, N3 will be sealed before shipment, please open it when first using the product.

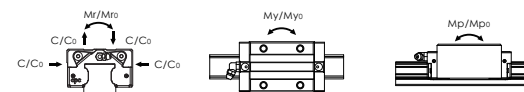

The above rating load capacities and static moments are calculated according to the ISO14728 standard. The rating life for basic dynamic load ratings is defined as the total 100km travel distance for 90% of a group of identical linear guides, under the same conditions and free from any material damage caused by rolling fatigue. If a standard of 50km travel distance is applied to measure the average product lifespan, the above basic dynamic load rating C should be multiplied by 1.26 for an accurate conversion.

Dimensions Table

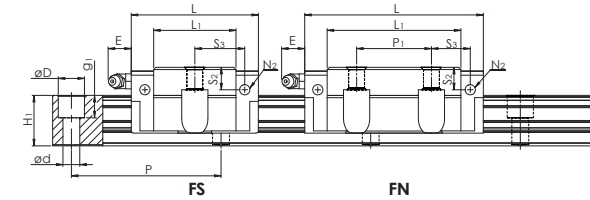
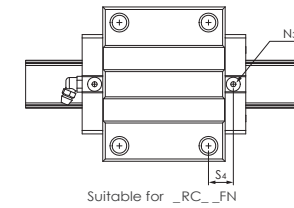
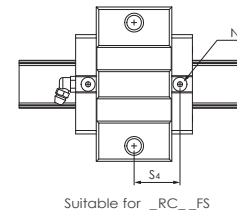
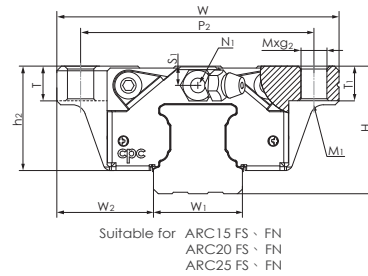
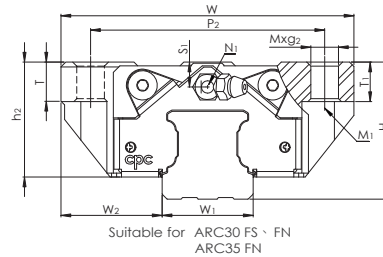

ARC FS Series

Model Code	Mounting Dimensions		Rail Dimensions(mm)				Block Dimensions(mm)										Block Dimensions(mm)					Load Capacities (KN)		Static Moment (Nm)			Weight		Model Code				
	H	W ₂	W ₁	H ₁	P	D _x xD _y	W	L	L ₁	h ₂	P ₁	P ₂	P ₃	Mxg ₂	M ₁	T	T ₁	N ₁	N ₂	N ₃	E	S ₁	S ₂	S ₃	S ₄	C	C ₀	M _{r0}		M _{p0}	M _{y0}	Block(g)	Rail(g/m)
ARC 15 FS	24	18.5	15	15	60	7.5x4.5x5.3	52	41.2	26	20.7	-	41	-	M5x7	M4	7	7	M3x6.5	M3x6	P3	3.5	4.5	7.5	15.6	16.7	7.7	12.1	100	50	50	132	1290	ARC 15 FS
ARC 20 FS	28	19.5	20	20	60	9.5x6x8.5	59	49.2	32.2	23	-	49	-	M6x10	M5	10	10	M3x7.5	M3x5.5	P4	10	4	7.4	19.1	19.8	12.5	19.3	205	100	100	210	2280	ARC 20 FS
ARC 25 FS	33	25	23	23	60	11x7x9	73	57.4	38.4	27	-	60	-	M8x10	M6	12	10	M6x7.5	M3x6.5	P4	12	5	9.3	22.2	23.2	18.2	27.3	350	160	160	345	3020	ARC 25 FS
ARC 30 FS	42	31	28	27	80	14x9x12	90	68	44	35.2	-	72	-	M10x12	M8	12	12	M6x8.5	M6x5	P5	12	7.5	12	27	26.8	23.3	33.1	520	230	230	750	4380	ARC 30 FS

ARC FN Series

ARC 15 FN	24	18.5	15	15	60	7.5x4.5x5.3	52	55.5	40.3	20.7	26	41	-	M5x7	M4	7	7	M3x6.5	M3x6	P3	3.5	4.5	7.5	8.9	10.9	9.9	17.5	140	105	105	200	1290	ARC 15 FN
ARC 20 FN	28	19.5	20	20	60	9.5x6x8.5	59	69	52	23	32	49	-	M6x10	M5	10	10	M3x7.5	M3x5.5	P4	10	4	7.4	13	13.7	17.1	30.0	325	230	230	336	2280	ARC 20 FN
ARC 25 FN	33	25	23	23	60	11x7x9	73	81.2	62.2	27	35	60	-	M8x10	M6	12	10	M6x7.5	M3x6.5	P4	12	5	9.3	16.6	17.6	24.8	42.5	540	385	385	524	3020	ARC 25 FN
ARC 30 FN	42	31	28	27	80	14x9x12	90	95.5	71.5	35.2	40	72	-	M10x12	M8	12	12	M6x8.5	M6x5	P5	12	7.5	12	20.8	20.5	32.8	53.7	845	565	565	1200	4380	ARC 30 FN
ARC 35 FN	48	33	34	32	80	14x9x12	100	111.2	86.2	40.4	50	82	-	M10x13	M8	13	13	M6x10	M6x7	P5	12	8	15	23.4	24.1	45.9	82.9	1700	1080	1080	1580	6790	ARC 35 FN

1. The load capacities is for full-ball type (without ball chain)
3. N₃ = O-ring size for lubrication from above

2. N₂ = Injecting holes
4. N₂, N₃ will be sealed before shipment, please open it when first using the product.

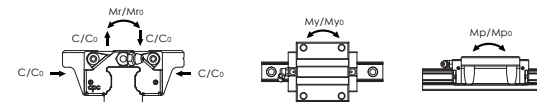

The above rating load capacities and static moments are calculated according to the ISO14728 standard. The rating life for basic dynamic load ratings is defined as the total 100km travel distance for 90% of a group of identical linear guides, under the same conditions and free from any material damage caused by rolling fatigue. If a standard of 50km travel distance is applied to measure the average product lifespan, the above basic dynamic load rating C should be multiplied by 1.26 for an accurate conversion.

Dimensions Table

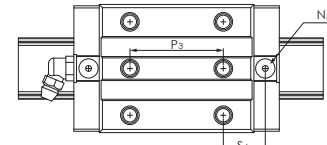
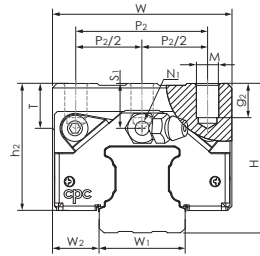
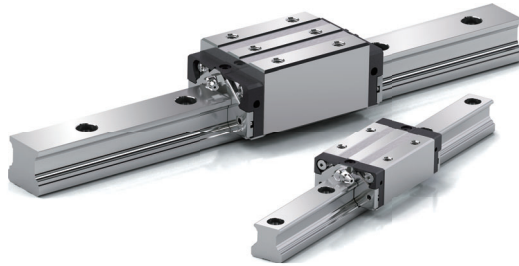

Suitable for _RC_ _MN-R

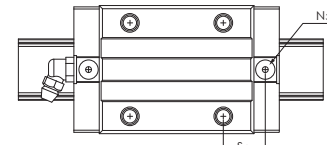

Suitable for _RC_ _MN

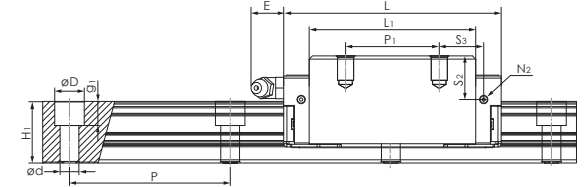

MN / MN-R

HRC MN Series

Model Code	Mounting Dimensions		Rail Dimensions(mm)				Block Dimensions(mm)											Load Capacities (kN)		Static Moment (Nm)			Weight		Model Code								
	H	W2	W1	H1	P	Dxdg1	W	L	L1	h2	P1	P2	P2/2	P3	Mxg2	M1	T	N1	N2	N3	E	S1	S2	S3		S4	C	C0	Mr0	Mp0	My0	Block(g)	Rail(g/m)
HRC 15 MN	28	9.5	15	15	60	7.5x4.5x5.3	34	55.5	40.3	24.7	26	26	-	-	M4x7	-	6	M3x6.5	M3x6	P3	3.5	8.5	11.5	9.8	10.9	9.9	17.5	140	105	105	200	1290	HRC 15 MN
HRC 15 MN-R													13	26																	190		HRC 15 MN-R
HRC 20 MN	30	12	20	20	60	9.5x6x8.5	44	69	52	25	36	32	-	-	M5x8.5	-	8	M3x7.5	M3x5.5	P4	10	6	9.4	11	11.7	17.1	30.0	325	230	230	318	2280	HRC 20 MN
HRC 20 MN-R													16	36																300		HRC 20 MN-R	
HRC 25 MN	40	12.5	23	23	60	11x7x9	48	81.2	62.2	34	35	35	-	-	M6x9	-	12	M6x7.5	M3x6.5	P4	12	12	16.3	16.6	17.6	24.8	42.5	540	385	385	578	3020	HRC 25 MN
HRC 25 MN-R													17.5	35																560		HRC 25 MN-R	
HRC 30 MN	45	16	28	27	80	14x9x12	60	95.5	71.5	38.2	40	40	-	-	M8x12	-	12	M6x8.5	M6x5	P5	12	10.5	15	20.8	20.5	32.8	53.7	845	565	565	896	4380	HRC 30 MN
HRC 30 MN-R													20	40																875		HRC 30 MN-R	
HRC 35 MN	55	18	34	32	80	14x9x12	70	111.2	86.2	47.4	50	50	-	-	M8x13	-	14	M6x10	M6x7	P5	12	15	22	23.4	24.1	45.9	82.9	1700	1080	1080	1430	6790	HRC 35 MN
HRC 35 MN-R													25	50																1370		HRC 35 MN-R	
HRC 45 MN	70	20.5	45	39	105	20x14x17	86	135.5	102.5	60.7	60	60	-	-	M10x20	-	14	PT1/8x12.5	M6x10.5	P5	14	21.1	28.1	27.3	27.3	71.3	122.1	3200	1910	1910	2794	10530	HRC 45 MN
HRC 45 MN-R													30	60																2650		HRC 45 MN-R	
HRC 55 MN	80	23.5	53	45.7	120	24x16x20	100	168.5	126.5	68	75	75	-	-	M12x25	-	16	M6x10	M6x13	P5	12	23.5	33.5	34.8	33.8	128	186	4949	3278	3278	5110	14000	HRC 55 MN
HRC 55 MN-R													37.5	75																4900		HRC 55 MN-R	

ERC MN Series

ERC 25 MN	36	12.5	23	23	60	11x7x9	48	81.2	62.2	30	35	35	-	-	M6x9	-	12	M6x7.5	M3x6.5	P4	12	8	12.3	16.6	17.6	24.8	42.5	540	385	385	470	3020	ERC 25 MN
ERC 25 MN-R													17.5	35																445		ERC 25 MN-R	

1. The load capacities is for full-ball type (without ball chain)
3. N3 = O-ring size for lubrication from above

2. N2 = Injecting holes
4. N2, N3 will be sealed before shipment, please open it when first using the product.

The above rating load capacities and static moments are calculated according to the ISO14728 standard. The rating life for basic dynamic load ratings is defined as the total 100km travel distance for 90% of a group of identical linear guides, under the same conditions and free from any material damage caused by rolling fatigue. If a standard of 50km travel distance is applied to measure the average product lifespan, the above basic dynamic load rating C should be multiplied by 1.26 for an accurate conversion.

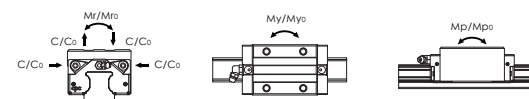

Dimensions Table

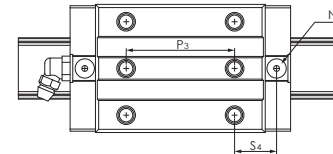
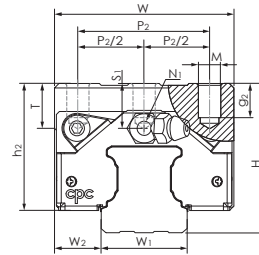
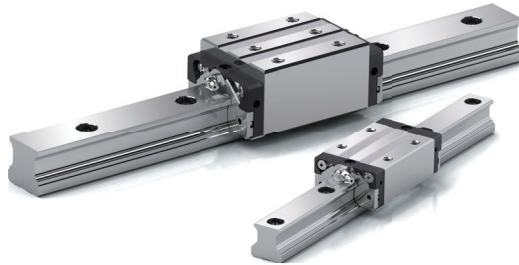

Suitable for _RC_ _ML-R

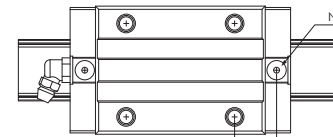

Suitable for _RC_ _ML

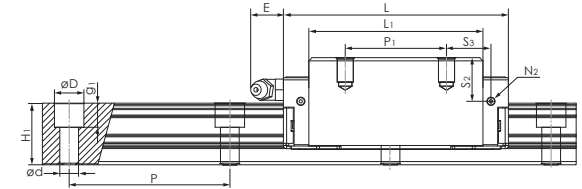

HRC ML Series

Model Code	Mounting Dimensions		Rail Dimensions(mm)				Block Dimensions(mm)											Block Dimensions(mm)				Load Capacities (kN)		Static Moment (Nm)			Weight		Model Code					
	H	W2	W1	H1	P	Dxdg1	W	L	L1	h2	P1	P2	P2/2	P3	Mxg2	M1	T	N1	N2	N3	E	S1	S2	S3	S4	C	C0	Mr0		Mp0	My0	Block(g)	Rail(g/m)	
HRC 15 ML	28	9.5	15	15	60	7.5x4.5x5.3	34	76.2	61	24.7	26	26	-	-	M4x7	-	6	M3x6.5	M3x6	P3	3.5	8.5	11.5	20.1	21.2	13.4	26.9	215	235	235	300	1290	HRC 15 ML	
HRC 15 ML-R													13	26																				HRC 15 ML-R
HRC 20 ML	30	12	20	20	60	9.5x6x8.5	44	87.2	70.2	25	50	32	-	-	M5x8.5	-	8	M3x7.5	M3x5.5	P4	10	6	9.4	13.1	13.8	20.4	38.5	415	390	390	400	2280	HRC 20 ML	
HRC 20 ML-R													26	50																				HRC 20 ML-R
HRC 25 ML	40	12.5	23	23	60	11x7x9	48	105	86	34	50	35	-	-	M6x9	-	12	M6x7.5	M3x6.5	P4	12	12	16.3	21	22	30.7	57.7	735	710	710	685	3020	HRC 25 ML	
HRC 25 ML-R													17.5	50																				HRC 25 ML-R
HRC 30 ML	45	16	28	27	80	14x9x12	60	118	94	38.2	60	40	-	-	M8x12	-	12	M6x8.5	M6x5	P5	12	10.5	15	21.7	21.8	39.6	70.2	1105	950	950	1150	4380	HRC 30 ML	
HRC 30 ML-R													20	60																				HRC 30 ML-R
HRC 35 ML	55	18	34	32	80	14x9x12	70	136.6	111.6	47.4	72	50	-	-	M8x13	-	14	M6x10	M6x7	P5	12	15	22	25.1	25.8	54.7	106.5	2185	1755	1755	1953	6790	HRC 35 ML	
HRC 35 ML-R													25	72																				HRC 35 ML-R
HRC 45 ML	70	20.5	45	39	105	20x14x17	86	171.5	138.5	60.7	80	60	-	-	M10x20	-	14	PT1/8x12.5	M6x10.5	P5	14	21.1	28.1	35.3	35.3	89.5	169.1	4430	3460	3460	4060	10530	HRC 45 ML	
HRC 45 ML-R													30	80																				HRC 45 ML-R
HRC 55 ML	80	23.5	53	45.7	120	24x16x20	100	202	160	68	95	75	-	-	M12x25	-	16	M6x10	M6x13	P5	12	23.5	33.5	41.5	40.5	147	226	6472	5284	5284	6243	14000	HRC 55 ML	
HRC 55 ML-R													37.5	95																				HRC 55 ML-R

ERC Series

ERC 25 M L	36	12.5	23	23	60	11x7x9	48	105	86	30	50	35	-	-	M6x9	-	12	M6x7.5	M3x6.5	P4	12	8	12.3	21	22	30.7	57.7	735	710	710	610	3020	ERC 25 M L	
ERC 25 M L-R													17.5	50																				ERC 25 M L-R

1. The load capacities is for full-ball type (without ball chain)
3. N3 = O-ring size for lubrication from above

2. N2 = Injecting holes
4. N2, N3 will be sealed before shipment, please open it when first using the product.

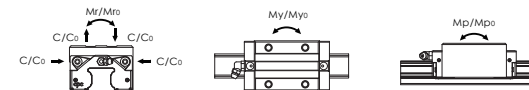

The above rating load capacities and static moments are calculated according to the ISO14728 standard. The rating life for basic dynamic load ratings is defined as the total 100km travel distance for 90% of a group of identical linear guides, under the same conditions and free from any material damage caused by rolling fatigue. If a standard of 50km travel distance is applied to measure the average product lifespan, the above basic dynamic load rating C should be multiplied by 1.26 for an accurate conversion.

Dimensions Table

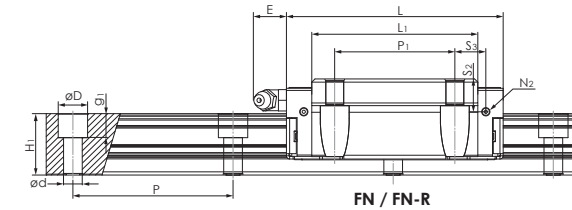
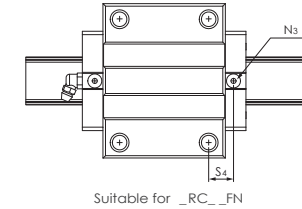
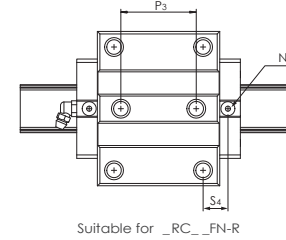
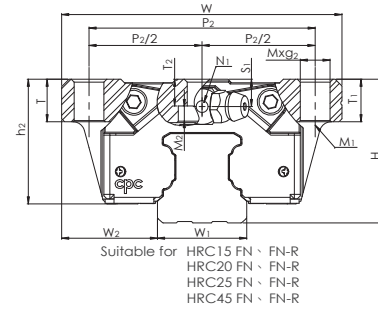
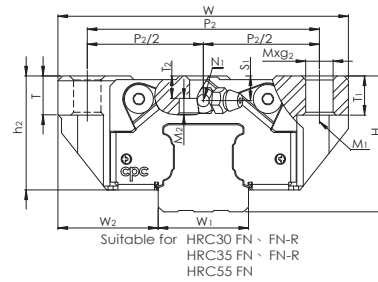
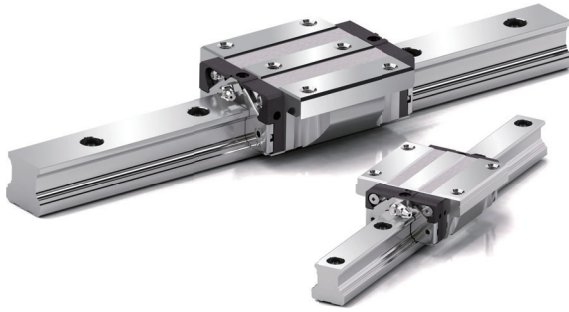

HRC FN Series

Model Code	Mounting Dimensions		Rail Dimensions(mm)				Block Dimensions(mm)										Block Dimensions(mm)								Load Capacities (KN)		Static Moment (Nm)			Weight		Model Code				
	H	W ₂	W ₁	H ₁	P	D _x d _x g ₁	W	L	L ₁	h ₂	P ₁	P ₂	P ₂ /2	P ₃	M _x G ₂	M ₁	M ₂	T	T ₁	T ₂	N ₁	N ₂	N ₃	E	S ₁	S ₂	S ₃	S ₄	C	C ₀	M _{ro}		M _{po}	M _{yo}	Block(g)	Rail(g/m)
HRC 15 FN	24	16	15	15	60	7.5x4.5x5.3	47	55.5	40.3	20.7	30	38	-	-	M5x7	M4	-	7	7	-	M3x6.5	M3x6	P3	3.5	4.5	7.5	7.8	8.9	9.9	17.5	140	105	105	190	1290	HRC 15 FN
HRC 15 FN-R													19	26			2.8		4.4															175		HRC 15 FN-R
HRC 20 FN	30	21.5	20	20	60	9.5x6x8.5	63	69	52	25	40	53	-	-	M6x10	M5	-	10	10	-	M3x7.5	M3x5.5	P4	10	6	9.4	9	9.7	17.1	30.0	325	230	230	396	2280	HRC 20 FN
HRC 20 FN-R													26.5	35			3.5		4.4														375		HRC 20 FN-R	
HRC 25 FN	36	23.5	23	23	60	11x7x9	70	81.2	62.2	30	45	57	-	-	M8x10	M6	-	12	10	-	M6x7.5	M3x6.5	P4	12	8	12.3	11.6	12.6	24.8	42.5	540	385	385	626	3020	HRC 25 FN
HRC 25 FN-R													28.5	40			4		6.3														550		HRC 25 FN-R	
HRC 30 FN	42	31	28	27	80	14x9x12	90	95.5	71.5	35.2	52	72	-	-	M10x12	M8	-	12	12	-	M6x8.5	M6x5	P5	12	7.5	12	14.8	14.5	32.8	53.7	845	565	565	1110	4380	HRC 30 FN
HRC 30 FN-R													36	44			5		6.8														1000		HRC 30 FN-R	
HRC 35 FN	48	33	34	32	80	14x9x12	100	111.2	86.2	40.4	62	82	-	-	M10x13	M8	-	13	13	-	M6x10	M6x7	P5	12	8	15	17.4	18.1	45.9	82.9	1700	1080	1080	1550	6790	HRC 35 FN
HRC 35 FN-R													41	52			5		7.3														1400		HRC 35 FN-R	
HRC 45 FN	60	37.5	45	39	105	20x14x17	120	135.5	102.5	50.7	80	100	-	-	M12x15	M10	-	18	15	-	PT1/8x12.5	M6x10.5	P5	14	11.1	18.1	17.3	17.3	71.3	122.1	3200	1910	1910	2747	10530	HRC 45 FN
HRC 45 FN-R													50	60			6		9.8														2550		HRC 45 FN-R	
HRC 55 FN	70	43.5	53	45.7	120	24x16x20	140	168.5	126.5	58	95	116	58	70	M14x18	M12	13	18	18	9.4	M6x10	M6x13	P5	12	13.5	23.5	24.8	23.8	128	186	4949	3278	3278	5440	14000	HRC 55 FN

1. The load capacities is for full-ball type (without ball chain)
 3. N₃ = O-ring size for lubrication from above
 5. M_xG₂: M1: Screw size based on ISO 4762:12.9
 6. M₂ abdomen countersunk head screw size according to DIN 7984-8.8

2. N₂ = Injecting holes
 4. N₂, N₃ will be sealed before shipment, please open it when first using the product.

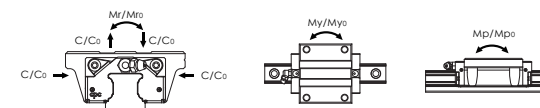

The above rating load capacities and static moments are calculated according to the ISO14728 standard. The rating life for basic dynamic load ratings is defined as the total 100km travel distance for 90% of a group of identical linear guides, under the same conditions and free from any material damage caused by rolling fatigue. If a standard of 50km travel distance is applied to measure the average product lifespan, the above basic dynamic load rating C should be multiplied by 1.26 for an accurate conversion.

Dimensions Table

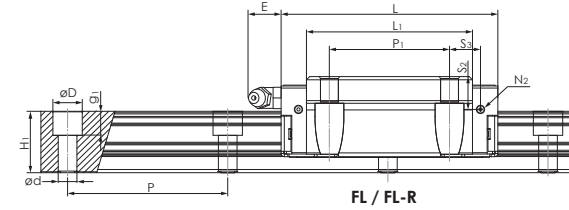
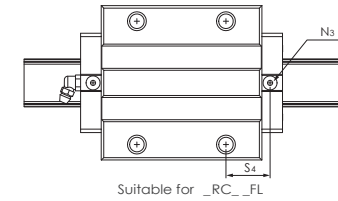
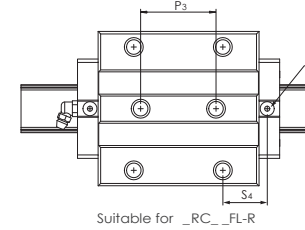
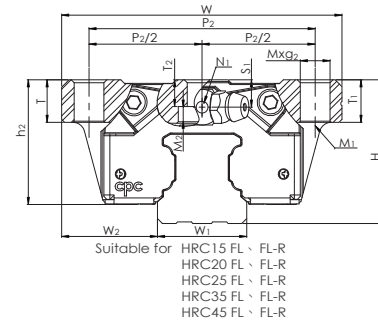
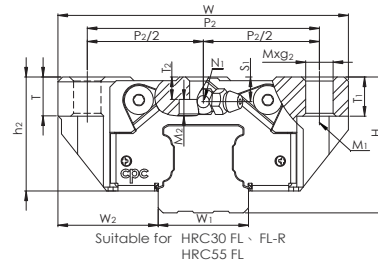
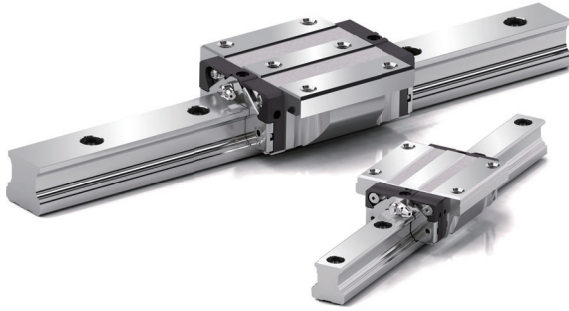

HRC FL Series

Model Code	Mounting Dimensions		Rail Dimensions(mm)				Block Dimensions(mm)										Block Dimensions(mm)				Load Capacities (KN)		Static Moment (Nm)			Weight		Model Code								
	H	W ₂	W ₁	H ₁	P	Dx dx g ₁	W	L	L ₁	h ₂	P ₁	P ₂	P ₂ /2	P ₃	Mxg ₂	M ₁	M ₂	T	T ₁	T ₂	N ₁	N ₂	N ₃	E	S ₁	S ₂	S ₃		S ₄	C	C ₀	M _{ro}	M _{po}	M _{yo}	Block(g)	Rail(g/m)
HRC 15 FL	24	16	15	15	60	7.5x4.5x5.3	47	76.2	61	20.7	30	38	-	-	M5x7	M4	-	7	7	-	M3x6.5	M3x6	P3	3.5	4.5	7.5	18.1	19.2	13.4	26.9	215	235	235	290	1290	HRC 15 FL
HRC 15 FL-R													19	26			2.8		4.4														270		HRC 15 FL-R	
HRC 20 FL	30	21.5	20	20	60	9.5x6x8.5	63	87.2	70.2	25	40	53	-	-	M6x10	M5	-	10	10	-	M3x7.5	M3x5.5	P4	10	6	9.4	18.1	18.8	20.4	38.5	415	390	390	504	2280	HRC 20 FL
HRC 20 FL-R													26.5	35			3.5		4.4													475		HRC 20 FL-R		
HRC 25 FL	36	23.5	23	23	60	11x7x9	70	105	86	30	45	57	-	-	M8x10	M6	-	12	10	-	M6x7.5	M3x6.5	P4	12	8	12.3	23.5	24.5	30.7	57.7	735	710	710	870	3020	HRC 25 FL
HRC 25 FL-R													28.5	40			4		6.3													810		HRC 25 FL-R		
HRC 30 FL	42	31	28	27	80	14x9x12	90	118	94	35.2	52	72	-	-	M10x12	M8	-	12	12	-	M6x8.5	M6x5	P5	12	7.5	12	25.7	25.8	39.6	70.2	1105	950	950	1385	4380	HRC 30 FL
HRC 30 FL-R													36	44			5		6.8													1290		HRC 30 FL-R		
HRC 35 FL	48	33	34	32	80	14x9x12	100	136.6	111.6	40.4	62	82	-	-	M10x13	M8	-	13	13	-	M6x10	M6x7	P5	12	8	15	30.1	30.8	54.7	106.5	2185	1755	1755	2000	6790	HRC 35 FL
HRC 35 FL-R													41	52			5		7.3													1800		HRC 35 FL-R		
HRC 45 FL	60	37.5	45	39	105	20x14x17	120	171.5	138.5	50.7	80	100	-	-	M12x15	M10	-	18	15	-	PT1/8x12.5	M6x10.5	P5	14	11.1	18.1	35.3	35.3	89.5	169.1	4430	3460	3460	4280	10530	HRC 45 FL
HRC 45 FL-R													50	60			6		9.8													4050		HRC 45 FL-R		
HRC 55 FL	70	43.5	53	45.7	120	24x16x20	140	202	160	58	95	116	-	-	M14x18	M12	-	18	18	-	M6x10	M6x13	P5	12	13.5	23.5	41.5	40.5	147	226	6472	5284	5284	6963	14000	HRC 55 FL

- The load capacities is for full-ball type (without ball chain)
- N₂ = Injecting holes
- N₃ = O-ring size for lubrication from above
- N₂, N₃ will be sealed before shipment, please open it when first using the product.
- Mxg₂, M₁: Screw size based on ISO 4762:12.9
- M₂ abdomen countersunk head screw size according to DIN 7984-8.8

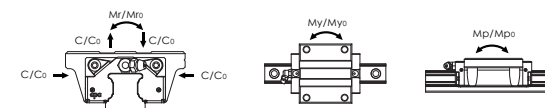

The above rating load capacities and static moments are calculated according to the ISO14728 standard. The rating life for basic dynamic load ratings is defined as the total 100km travel distance for 90% of a group of identical linear guides, under the same conditions and free from any material damage caused by rolling fatigue. If a standard of 50km travel distance is applied to measure the average product lifespan, the above basic dynamic load rating C should be multiplied by 1.26 for an accurate conversion.

Dimensions Table

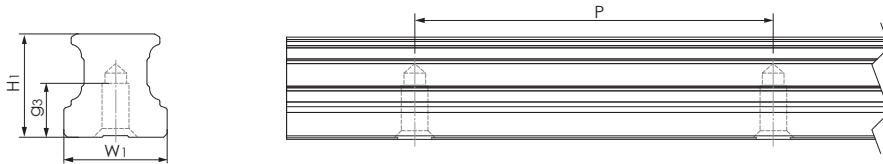

Rail (tapped from the bottom)

Model Code	W1	H1	P	Mxg3	Lmax	Rail(g/m)
ARU 15	15	15	60	M5x8	4000	1290
ARU 20	20	20	60	M6x10	4000	2280
ARU 25	23	23	60	M6x12	4000	3020
ARU 30	28	27	80	M8x15	4000	4380
ARU 35	34	32	80	M8x15	4000	6790
ARU 45	45	39	105	M12x19	4000	10530
ARU 55	53	45.7	120	M14x24	4000	14060

Nipple Option

	Type			Nipple size		Grease nipple	Optional			
				Section	Side		Standard	Straight adapter	Tube diameter	L-Type adapter
Ball	ARC15	HRC15	-	M3	M3	A-M3	OA-M3-D4	-	OB-M3-M6	-
	ARC20	HRC20	-	M3	M3	B-M3	OA-M3-D4	-	OB-M3-M6	-
	ARC25	HRC25	ERC25	M6	M3	A/B-M6	OA-M6-M8	Ø4	OB-M6-M8	Ø4
	ARC30	HRC30	-	M6	M6	A/B-M6	OA-M6-M8	Ø4	OB-M6-M8	Ø4
							OA-M6-PT1/8	-	OB-M6-PT1/8	-
							OA-M6-G1/8	Ø6	OB-M6-PT1/8	-
	ARC35	HRC35	-	M6	M6	A/B-M6	OA-M6-M8	Ø4	OB-M6-M8	-
							OA-M6-PT1/8	-	OB-M6-PT1/8	-
							OA-M6-G1/8	Ø6	OB-M6-PT1/8	-
	ARC45	HRC45	-	PT1/8	M6	B-PT1/8	OA-PT1/8-M8	Ø4	OB-PT1/8-M8	Ø4
							OA-PT1/8-PT1/8	-	OB-PT1/8-PT1/8	-
							OA-PT1/8-G1/8	Ø6	OB-PT1/8-PT1/8	-
ARC55	HRC55	-	M6	M6	A/B-M6	OA-M6-M8	Ø4	OB-M6-M8	Ø4	
						OA-M6-PT1/8	-	OB-M6-PT1/8	-	
						OA-M6-G1/8	Ø6	OB-M6-PT1/8	-	
Roller	ARR35	HRR35	LRR35	M6	M6	A/B-M6-L	OA-M6-M8-L	Ø4	OB-M6-M8-L	Ø4
							OA-M6-PT1/8-L	-	OB-M6-PT1/8-L	-
							OA-M6-G1/8-L	Ø6	OB-M6-PT1/8-L	-
	ARR45	HRR45	LRR45	M6	M6	A/B-M6-L	OA-M6-M8-L	Ø4	OB-M6-M8-L	Ø4
							OA-M6-PT1/8-L	-	OB-M6-PT1/8-L	-
							OA-M6-G1/8-L	Ø6	OB-M6-PT1/8-L	-

* When external NRB seal is chosen (SN), please use long type grease nipple for ball type product, extra long type grease nipple for roller type product.



WRC series
Wide Rail Ball Type Linear Guide Series

Ordering information

Model code

WRC	U	21/15	M	N	B	2	C	V1	P	-1480L	-20	-20	11	/J
Customization code (Please refer to page 30)														
Number of rails on the same moving axis														
End hole pitch (mm)														
Starting hole pitch (mm)														
Rail length (mm)														
Accuracy grade : UP, SP, P, H, N (Please refer to page 29)														
Preload class : VC, V0, V1, V2 (Please refer to page 23)														
C: with ball chain (Please refer to page 07)														
Block quantity														
Seal type : B: Low friction														
Block length : N: standard														
Block width : M: standard F: flanged														
Block type : 21/15, 27/20														
U: rail (tapped from the bottom)														
Product type : WRC: Wide Rail Ball Type Linear Guide Series														

Dimensions Table

WRU Series Rail (tapped from the bottom)

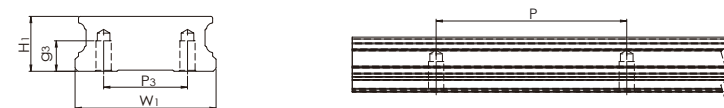

Model Code	W1	H1	P	P3	Mxg3	Lmax	Rail(g/m)
WRU 21/15	37	14.4	50	22	M4x8	4000	3596
WRU 27/20	42	18.5	60	24	M5x7.5	4000	5259

Dimensions Table

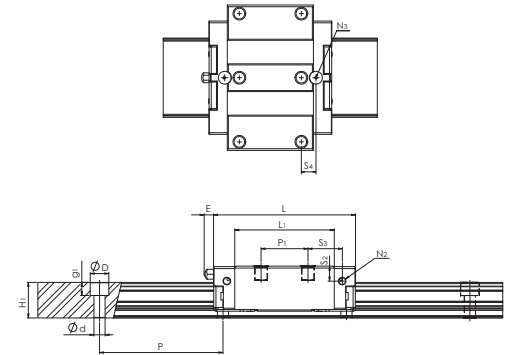
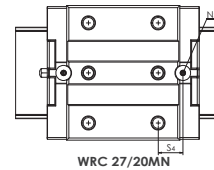
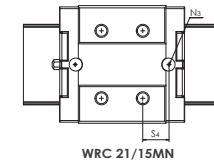
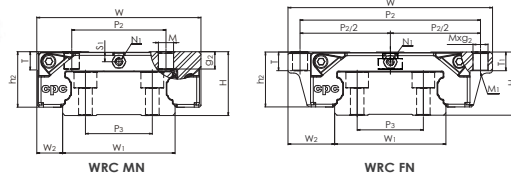

WRC Series

Model Code	Mounting Dimensions		Rail Dimensions(mm)				Block Dimensions(mm)											Block Dimensions(mm)				Load Capacities (KN)		Static Moment (Nm)			Weight		Model Code						
	H	W2	W1	H1	P	P3	Dxdg1	W	L	L1	h2	P1	P2	P2/2	Mxg2	M1	T	Ti	N1	N2	N3	E	S1	S2	S3	S4	Ciso			Co	Mro	Mpo	Myo	Block(g)	Rail(g/m)
																											100km	50km							
WRC 21/15 MN	21	8.5	37	14.4	50	22	7.5x4.5x5.3	54	57.5	40.3	18.3	19	31	-	M5x5	-	6	-	M3	M3x3	P3	3.5	3.3	6.1	13.9	11.9	9.9	12.5	17.5	315	105	105	160	3596	WRC 21/15 MN
WRC 21/15 FN	21	15.5	37	14.4	50	22	7.5x4.5x5.3	68	57.5	40.3	18.3	29	60	30	M5x7	M4	7	7	M3	M3x3	P3	3.5	3.3	6.1	8.9	6.9	9.9	12.5	17.5	315	105	105	198	3596	WRC 21/15 FN
WRC 27/20 MN	27	10	42	18.5	60	24	7.5x4.5x5.3	62	70	52	23.5	32	46	23	M6x6	-	10	-	M3	M3x4	P4	3.5	4.5	8	13.2	11.5	17.1	21.5	30	634	230	230	320	5259	WRC 27/20 MN
WRC 27/20 FN	27	19	42	18.5	60	24	7.5x4.5x5.3	80	70	52	23.5	40	70	35	M6x9	M5	9	9	M3	M3x4	P4	3.5	4.5	8	9.2	7.5	17.1	21.5	30	634	230	230	553	5259	WRC 27/20 FN

The above rating load capacities and static moments are calculated according to the ISO 14728 standard. The rating life for basic dynamic load ratings is defined as the total 100km travel distance for 90% of a group of identical linear guides under the same conditions and free from any material damage caused by rolling fatigue. If a standard of 50km travel distance is applied to measure the average product lifespan, the above basic dynamic load rating C should be multiplied by 1.26 for an accurate conversion.

WRC...C Series Ball chain type

Model Code	Mounting Dimensions		Rail Dimensions(mm)				Block Dimensions(mm)											Block Dimensions(mm)				Load Capacities (KN)		Static Moment (Nm)			Weight		Model Code						
	H	W2	W1	H1	P	P3	Dxdg1	W	L	L1	h2	P1	P2	P2/2	Mxg2	M1	T	Ti	N1	N2	N3	E	S1	S2	S3	S4	Ccage			Co	Mro	Mpo	Myo	Block(g)	Rail(g/m)
																											100km	50km							
WRC 21/15MN...C	21	8.5	37	14.4	50	22	7.5x4.5x5.3	54	57.5	40.3	18.3	19	31	-	M5x5	-	6	-	M3	M3x3	P3	3.5	3.3	6.1	13.9	11.9	11.8	14.9	16.2	295	95	95	159	3596	WRC 21/15MN...C
WRC 21/15FN...C	21	15.5	37	14.4	50	22	7.5x4.5x5.3	68	57.5	40.3	18.3	29	60	30	M5x7	M4	7	7	M3	M3x3	P3	3.5	3.3	6.1	8.9	6.9	11.8	14.9	16.2	295	95	95	197.5	3596	WRC 21/15FN...C
WRC 27/20MN...C	27	10	42	18.5	60	24	7.5x4.5x5.3	62	70	52	23.5	32	46	23	M6x6	-	10	-	M3	M3x4	P4	3.5	4.5	8	13.2	11.5	22.3	28.1	25.7	535	200	200	318	5259	WRC 27/20MN...C
WRC 27/20FN...C	27	19	42	18.5	60	24	7.5x4.5x5.3	80	70	52	23.5	40	70	35	M6x9	M5	9	9	M3	M3x4	P4	3.5	4.5	8	9.2	7.5	22.3	28.1	25.7	535	200	200	550	5259	WRC 27/20FN...C

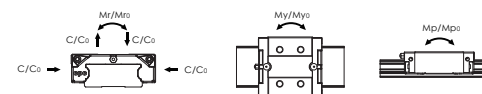

The dynamic load rating value with ball chain Ccage is the measured value (please refer to page 08). The above static load rating and the static moment are calculated according to the ISO 14728 standard.



ARR/HRR/LRR series
Roller-type Linear Guide

Product Overview

LRR Extremely Low Profile Type

Suitable for conditions where a lower external torque and inertial force is required, this product combines a low height and center of gravity to provide a more compact product. ARR, HRR and LRRs blocks all share the same rail with a similar load capacity and service life.

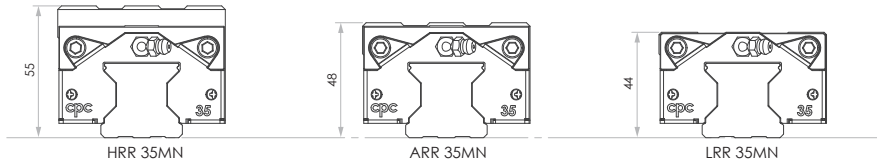

MXL Ultra Long Block Type

Compared to the industry's ML lengthened block, the MXL model's much lengthened block features a greater load, rigidity and shock reduction capability. This makes this model most suitable for machine tools that require super high rigidity and accuracy.

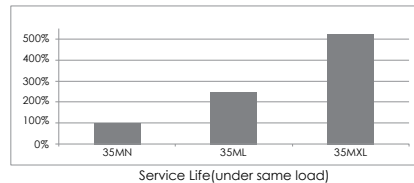
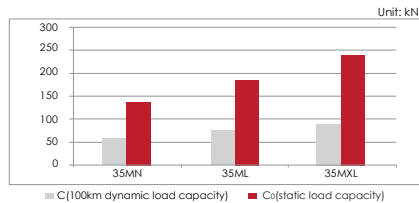
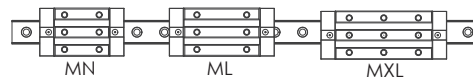

Dimensions Table

ARRU Series Rail (tapped from the bottom)

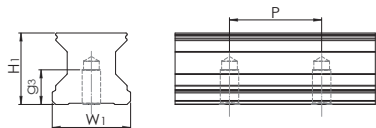

Model Code	W1	H1	P	Mxg3	Lmax	Rail(g/m)
ARRU 35	34	31	40	M8x15	4000	5740
ARRU 45	45	38	52.5	M12x19	4000	10000

Parts information

Low Noise Roller Chain (Optional)

Our Ball chain design effectively lowers high frequency noise volumes while sliding and enhancing smoothness. Additionally, the ball chain spacer between steel rollers continuously replenishes the oil film cladding to maintain a better lubrication effect.

(For more information please refer to page 07)

Full Cover Seal (Standard Feature)

All model type are equipped with an "end seal", "bottom seal", and "inner seal" to effectively prevent foreign objects from sliding into the block or lubrication from leaking out.

(For more information please refer to page 03)

NBR Seal (Optional)

The seal demonstrates a high dustproof ability to be used in high dust particle working environments, being ideally placed in wood-working machines, glass processing machines, graphite processing machines and grinders. On the outer side of the seal is equipped a stainless steel scraper, with the clearance between the inner and rail contour measuring at only 0.2-0.3mm. This can prevent comparatively large foreign objects from damaging the rubber seal.

(For more information please refer to page 09)

High Rigidity Stainless Steel Reinforcement Plate (Standard Feature)

Our L-shaped design is locked with end and bottom screws on the block body. The bottom of the body is equipped with an integrated bolt, which allows for the tight fixing of the reinforcement plate to prevent unnecessary block damage from cracking the plastic mountings.

(For more information please refer to page 06)

Metal-Plastic-Cap (Standard Feature)

Stainless steel covers can demonstrate excellent friction resistance under harsh environments. Inside, the hole plug is equipped with fixed plastic support, enabling for easy installation and direct installation on a standard rail. Contact between the unit support part and stigma screws can prevent overly deep fastening during installation, while also preventing cap indentation and foreign objects from stacking while sliding.

(For more information please refer to page 10)

Ordering Information

Model Code

ARR	U	35	M	N	S	2	C	V1	P	-1480L	-20	-20	II	/J	Customization code (please refer to page 30)
													Number of rails on the same moving axis		
													End hole pitch(mm)		
													Starting hole pitch(mm)		
													Rail length(mm)		
													Accuracy grade: UP, SP, P, H (please refer to page 29)		
													Preload class: V0, V1, V2		
													C: with ball chain (please refer to page 07)		
													Block quantity		
													Seal type: S:standard		
													Block length: N:standard L:long XL:extra long		
													Block width: M:standard F:flanged		
													Block type: 35, 45		
													U: Rail (tapped from the bottom)		
													Product type: ARR: Low Profile Type HRR: High Profile Type LRR: Extremely Low Profile Type		

Dimensions Table

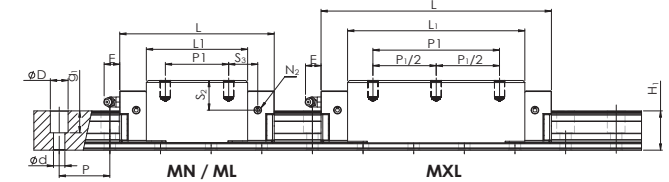
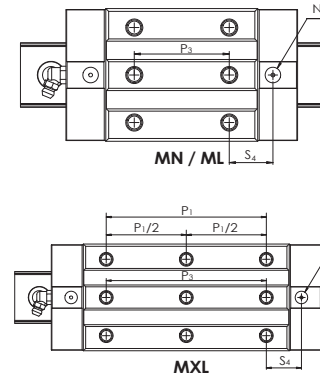
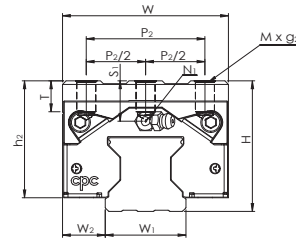
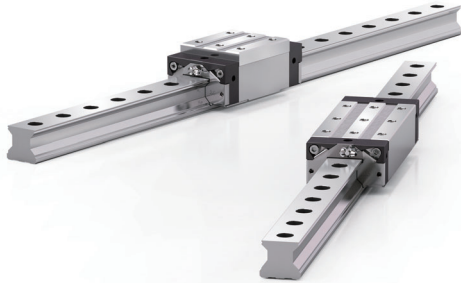

ARR MN/ML/MXL Series

Model Code	Mounting Dimensions		Rail Dimensions(mm)				Block Dimensions(mm)										Block Dimensions(mm)				Load Capacities (KN)		Static Moment (Nm)			Weight		Model Code						
	H	W ₂	W ₁	H ₁	P	D _x d _x g ₁	W	L	L ₁	h ₂	P ₁	P _{1/2}	P ₂	P _{2/2}	P ₃	Mxg ₂	M ₁	T	N ₁	N ₂	N ₃	E	S ₁	S ₂	S ₃	S ₄	C _{iso} 100km		C ₀	M _{r0}	M _{p0}	M _{y0}	Block(g)	Rail(g/m)
ARR 35MN	48	18	34	31	40	14x9x17	70	122	84	42	50	-	50	25	50	M8x13	-	13	M6x12	M6x8	P5	12	10	16.4	25	25	57	154	2742	1946	1946	1200	5740	ARR 35MN
ARR 35ML	48	18	34	31	40	14x9x17	70	147.5	109.5	42	72	-	50	25	72	M8x13	-	13	M6x12	M6x8	P5	12	10	16.4	26.7	26.7	68.9	196	3525	3226	3226	1750	5740	ARR 35ML
ARR 45MN	60	20.5	45	38	52.5	20x14x17	86	156	110	52	60	-	60	30	60	M10x17	-	13	M6x12	M6x8	P6	12	14.6	21.8	39.2	36	95.9	255	6350	4450	4450	2600	10000	ARR 45MN
ARR 45ML	60	20.5	45	38	52.5	20x14x17	86	191	145	52	80	-	60	30	80	M10x17	-	13	M6x12	M6x8	P6	12	14.6	21.8	46.7	43.5	118	333	8450	7700	7700	3350	10000	ARR 45ML

HRR MN/ML/MXL Series

HRR 35MN	55	18	34	31	40	14x9x17	70	122	84	49	50	-	50	25	50	M8x16	-	13	M6x12	M6x8	P5	12	17	23.4	25	25	57	154	2742	1946	1946	1720	5740	HRR 35MN
HRR 35ML	55	18	34	31	40	14x9x17	70	147.5	109.5	49	72	-	50	25	72	M8x16	-	13	M6x12	M6x8	P5	12	17	23.4	26.7	26.7	68.9	196	3525	3226	3226	2100	5740	HRR 35ML
HRR 35MXL	55	18	34	31	40	14x9x17	70	177.5	139.5	49	100	50	50	25	100	M8x16	-	13	M6x12	M6x8	P5	12	17	23.4	27.7	27.7	82	245	4439	5111	5111	2700	5740	HRR 35MXL
HRR 45MN	70	20.5	45	38	52.5	20x14x17	86	156	110	62	60	-	60	30	60	M10x20	-	13	M6x12	M6x8	P6	12	24.6	31.8	39.2	36	95.9	255	6350	4450	4450	3400	10000	HRR 45MN
HRR 45ML	70	20.5	45	38	52.5	20x14x17	86	191	145	62	80	-	60	30	80	M10x20	-	13	M6x12	M6x8	P6	12	24.6	31.8	46.7	43.5	118	333	8450	7700	7700	4300	10000	HRR 45ML
HRR 45MXL	70	20.5	45	38	52.5	20x14x17	86	226	180	62	120	60	60	30	120	M10x20	-	13	M6x12	M6x8	P6	12	24.6	31.8	44.2	41	138	410	10500	11800	11800	5200	10000	HRR 45MXL

LRR MN/ML/MXL Series

LRR 35MN	44	18	34	31	40	14x9x17	70	122	84	38	50	-	50	25	50	M8x9	-	9	M6x12	M6x8	P5	12	6	12.4	25	25	57	154	2742	1946	1946	1100	5740	LRR 35MN
LRR 35ML	44	18	34	31	40	14x9x17	70	147.5	109.5	38	72	-	50	25	72	M8x9	-	9	M6x12	M6x8	P5	12	6	12.4	26.7	26.7	68.9	196	3525	3226	3226	1500	5740	LRR 35ML
LRR 35MXL	44	18	34	31	40	14x9x17	70	177.5	139.5	38	100	50	50	25	100	M8x9	-	9	M6x12	M6x8	P5	12	6	12.4	27.7	27.7	82	245	4439	5111	5111	1900	5740	LRR 35MXL
LRR 45MN	52	20.5	45	38	52.5	20x14x17	86	156	110	44	60	-	60	30	60	M10x11	-	10	M6x12	M6x8	P6	12	6.6	13.8	39.2	36	95.9	255	6350	4450	4450	2100	10000	LRR 45MN
LRR 45ML	52	20.5	45	38	52.5	20x14x17	86	191	145	44	80	-	60	30	80	M10x11	-	10	M6x12	M6x8	P6	12	6.6	13.8	46.7	43.5	118	333	8450	7700	7700	2700	10000	LRR 45ML
LRR 45MXL	52	20.5	45	38	52.5	20x14x17	86	226	180	44	120	60	60	30	120	M10x11	-	10	M6x12	M6x8	P6	12	6.6	13.8	44.2	41	138	410	10500	11800	11800	3200	10000	LRR 45MXL

1. N₂ = Injecting holes
2. N₃ = O-ring size for lubrication from above
3. N₂, N₃ will be sealed before shipment, please open it when first using the product.

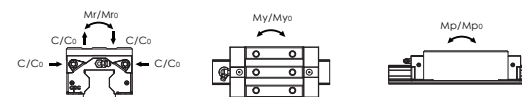

The above rating load capacities and static moments are calculated according to the ISO 14728 standard. The rating life for basic dynamic load ratings is defined as the total 100km travel distance for 90% of a group of identical linear guides, under the same conditions and free from any material damage caused by rolling fatigue. If a standard of 50km travel distance is applied to measure the average product lifespan, the above basic dynamic load rating C should be multiplied by 1.23 for an accurate conversion.

Dimensions Table

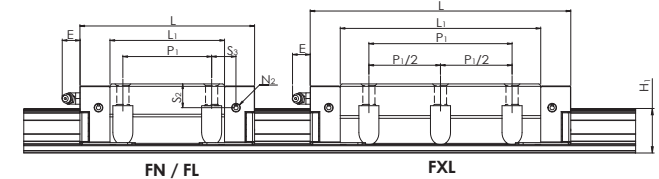
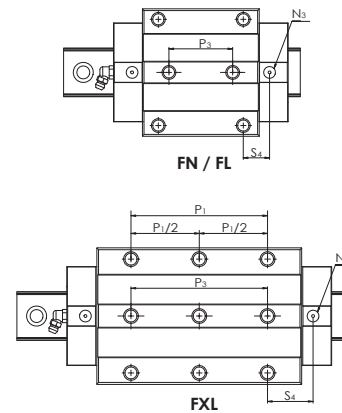
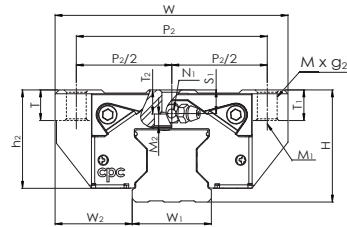
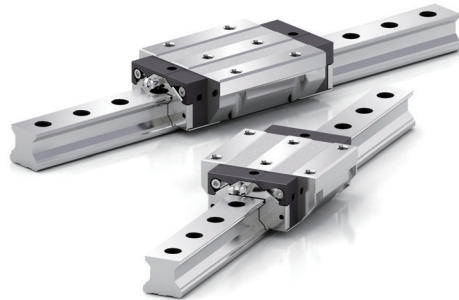

HRR FN/FL/FXL Series

Model Code	Mounting Dimensions		Rail Dimensions(mm)				Block Dimensions(mm)											Block Dimensions(mm)				Load Capacities (KN)		Static Moment (Nm)			Weight		Model Code								
	H	W ₂	W ₁	H ₁	P	D _x d _x g ₁	W	L	L ₁	h ₂	P ₁	P ₁ /2	P ₂	P ₂ /2	P ₃	M x G ₂	M ₁	M ₂	T	T ₁	T ₂	N ₁	N ₂	N ₃	E	S ₁	S ₂	S ₃		S ₄	C _{iso 100km}	C ₀	M _{r0}	M _{p0}	M _{y0}	Block(g)	Rail(g/m)
HRR 35FN	48	33	34	31	40	14x9x17	100	122	84	42	62	-	82	41	52	M10x13	M8	5	13	13	10.2	M6x12	M6x8	P5	12	10	16.4	19	19	57	154	2742	1946	1946	1700	5740	HRR 35FN
HRR 35FL	48	33	34	31	40	14x9x17	100	147.5	109.5	42	62	-	82	41	52	M10x13	M8	5	13	13	10.2	M6x12	M6x8	P5	12	10	16.4	31.7	31.7	68.9	196	3525	3226	3226	2400	5740	HRR 35FL
HRR 35FXL	48	33	34	31	40	14x9x17	100	177.5	139.5	42	100	50	82	41	100	M10x13	M8	5	13	13	10.2	M6x12	M6x8	P5	12	10	16.4	27.7	27.7	82	245	4439	5111	5111	3100	5740	HRR 35FXL
HRR 45FN	60	37.5	45	38	52.5	20x14x17	120	156	110	52	80	-	100	50	60	M12x15	M10	6	15	15	14.8	M6x12	M6x8	P6	12	14.6	21.8	29.2	26	95.9	255	6350	4450	4450	3600	10000	HRR 45FN
HRR 45FL	60	37.5	45	38	52.5	20x14x17	120	191	145	52	80	-	100	50	60	M12x15	M10	6	15	15	14.8	M6x12	M6x8	P6	12	14.6	21.8	46.7	43.5	118	333	8450	7700	7700	4700	10000	HRR 45FL
HRR 45FXL	60	37.5	45	38	52.5	20x14x17	120	226	180	52	120	60	100	50	120	M12x15	M10	6	15	15	14.8	M6x12	M6x8	P6	12	14.6	21.8	44.2	41	138	410	10500	11800	11800	5750	10000	HRR 45FXL

LRR FN/FL/FXL Series

LRR 35FN	44	33	34	31	40	14x9x17	100	122	84	38	62	-	82	41	52	M10x13	M8	5	9	13	6.7	M6x12	M6x8	P5	12	6	12.4	19	19	57	154	2742	1946	1946	1550	5740	LRR 35FN
LRR 35FL	44	33	34	31	40	14x9x17	100	147.5	109.5	38	62	-	82	41	52	M10x13	M8	5	9	13	6.7	M6x12	M6x8	P5	12	6	12.4	31.7	31.7	68.9	196	3525	3226	3226	2200	5740	LRR 35FL
LRR 35FXL	44	33	34	31	40	14x9x17	100	177.5	139.5	38	100	50	82	41	100	M10x13	M8	5	9	13	6.7	M6x12	M6x8	P5	12	6	12.4	27.7	27.7	82	245	4439	5111	5111	2800	5740	LRR 35FXL
LRR 45FN	52	37.5	45	38	52.5	20x14x17	120	156	110	44	80	-	100	50	60	M12x15	M10	6	10	15	7.3	M6x12	M6x8	P6	12	6.6	13.8	29.2	26	95.9	255	6350	4450	4450	2900	10000	LRR 45FN
LRR 45FL	52	37.5	45	38	52.5	20x14x17	120	191	145	44	80	-	100	50	60	M12x15	M10	6	10	15	7.3	M6x12	M6x8	P6	12	6.6	13.8	46.7	43.5	118	333	8450	7700	7700	3800	10000	LRR 45FL
LRR 45FXL	52	37.5	45	38	52.5	20x14x17	120	226	180	44	120	60	100	50	120	M12x15	M10	6	10	15	7.3	M6x12	M6x8	P6	12	6.6	13.8	44.2	41	138	410	10500	11800	11800	4500	10000	LRR 45FXL

1. The load capacity is measured for the full-ball type (without ball chain)

2. N₂ = injecting holes

3. N₃ = O-ring size for lubrication from above

4. N₂, N₃ will be sealed before shipment, please open it when first using the product.

5. M_xG₂, M₁: Screw size based on ISO 4762-12.9

6. M₂ abdomen countersunk head screw size according to DIN 7984-8.8

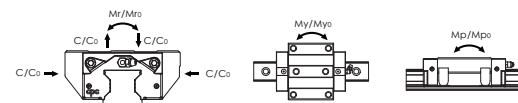

The above rating load capacities and static moments are calculated according to the ISO 14728 standard. The rating life for basic dynamic load ratings is defined as the total 100km travel distance for 90% of a group of identical linear guides, under the same conditions and free from any material damage caused by rolling fatigue. If a standard of 50km travel distance is applied to measure the average product lifespan, the above basic dynamic load rating C should be multiplied by 1.23 for an accurate conversion.

Dimensions Table

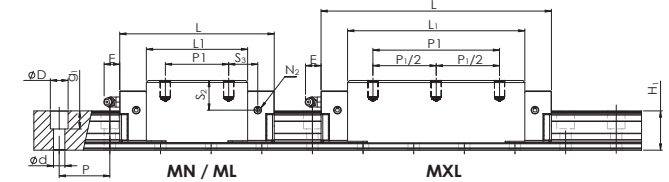
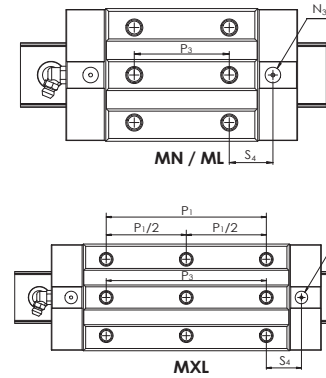
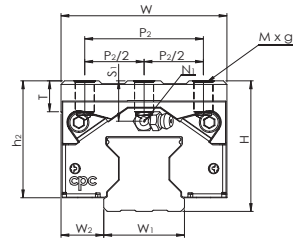
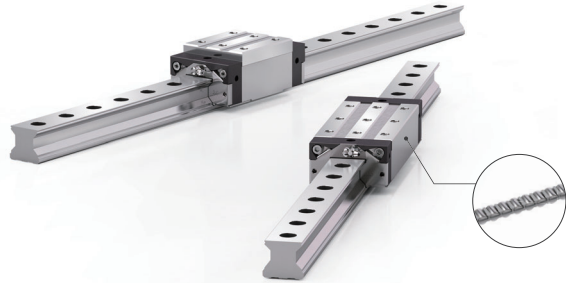

ARR MN/ML/MXL...C Series (Ball chain type)

Model Code	Mounting Dimensions		Rail Dimensions(mm)				Block Dimensions(mm)							Block Dimensions(mm)							Load Capacities (kN)		Static Moment (Nm)			Weight		Model Code						
	H	W ₂	W ₁	H ₁	P	D _x d _x g ₁	W	L	L ₁	h ₂	P ₁	P _{1/2}	P ₂	P _{2/2}	P ₃	M x G ₂	M ₁	T	N ₁	N ₂	N ₃	E	S ₁	S ₂	S ₃	S ₄	C _{Cage} 100km		C ₀	M _{r0}	M _{p0}	M _{y0}	Block(g)	Rail(g/m)
ARR 35MN	48	18	34	31	40	14x9x17	70	122	84	42	50	-	50	25	50	M8x13	-	13	M6x12	M6x8	P5	12	10	16.4	25	25	71.3	133	2350	1710	1710	1200	5740	ARR 35MN
ARR 35ML	48	18	34	31	40	14x9x17	70	147.5	109.5	42	72	-	50	25	72	M8x13	-	13	M6x12	M6x8	P5	12	10	16.4	26.7	26.7	86.1	175	3133	2881	2881	1750	5740	ARR 35ML
ARR 45MN	60	20.5	45	38	52.5	20x14x17	86	156	110	52	60	-	60	30	60	M10x17	-	13	M6x12	M6x8	P6	12	14.6	21.8	39.2	36	120	222	5750	4050	4050	2600	10000	ARR 45MN
ARR 45ML	60	20.5	45	38	52.5	20x14x17	86	191	145	52	80	-	60	30	80	M10x17	-	13	M6x12	M6x8	P6	12	14.6	21.8	46.7	43.5	147.5	288	7550	6900	6900	3350	10000	ARR 45ML

HRR MN/ML/MXL...C Series (Ball chain type)

HRR 35MN	55	18	34	31	40	14x9x17	70	122	84	49	50	-	50	25	50	M8x16	-	13	M6x12	M6x8	P5	12	17	23.4	25	25	71.3	133	2350	1710	1710	1720	5740	HRR 35MN
HRR 35ML	55	18	34	31	40	14x9x17	70	147.5	109.5	49	72	-	50	25	72	M8x16	-	13	M6x12	M6x8	P5	12	17	23.4	26.7	26.7	86.1	175	3133	2881	2881	2100	5740	HRR 35ML
HRR 35MXL	55	18	34	31	40	14x9x17	70	177.5	139.5	49	100	50	50	25	100	M8x16	-	13	M6x12	M6x8	P5	12	17	23.4	27.7	27.7	102.5	224	4047	4695	4695	2700	5740	HRR 35MXL
HRR 45MN	70	20.5	45	38	52.5	20x14x17	86	156	110	62	60	-	60	30	60	M10x20	-	13	M6x12	M6x8	P6	12	24.6	31.8	39.2	36	120	222	5750	4050	4050	3400	10000	HRR 45MN
HRR 45ML	70	20.5	45	38	52.5	20x14x17	86	191	145	62	80	-	60	30	80	M10x20	-	13	M6x12	M6x8	P6	12	24.6	31.8	46.7	43.5	147.5	288	7550	6900	6900	4300	10000	HRR 45ML
HRR 45MXL	70	20.5	45	38	52.5	20x14x17	86	226	180	62	120	60	60	30	120	M10x20	-	13	M6x12	M6x8	P6	12	24.6	31.8	44.2	41	172.5	366	9650	10850	10850	5200	10000	HRR 45MXL

LRR MN/ML/MXL...C Series (Ball chain type)

LRR 35MN	44	18	34	31	40	14x9x17	70	122	84	38	50	-	50	25	50	M8x9	-	9	M6x12	M6x8	P5	12	6	12.4	25	25	71.3	133	2350	1710	1710	1100	5740	LRR 35MN
LRR 35ML	44	18	34	31	40	14x9x17	70	147.5	109.5	38	72	-	50	25	72	M8x9	-	9	M6x12	M6x8	P5	12	6	12.4	26.7	26.7	86.1	175	3133	2881	2881	1500	5740	LRR 35ML
LRR 35MXL	44	18	34	31	40	14x9x17	70	177.5	139.5	38	100	50	50	25	100	M8x9	-	9	M6x12	M6x8	P5	12	6	12.4	27.7	27.7	102.5	224	4047	4695	4695	1900	5740	LRR 35MXL
LRR 45MN	52	20.5	45	38	52.5	20x14x17	86	156	110	44	60	-	60	30	60	M10x11	-	10	M6x12	M6x8	P6	12	6.6	13.8	39.2	36	120	222	5750	4050	4050	2100	10000	LRR 45MN
LRR 45ML	52	20.5	45	38	52.5	20x14x17	86	191	145	44	80	-	60	30	80	M10x11	-	10	M6x12	M6x8	P6	12	6.6	13.8	46.7	43.5	147.5	288	7550	6900	6900	2700	10000	LRR 45ML
LRR 45MXL	52	20.5	45	38	52.5	20x14x17	86	226	180	44	120	60	60	30	120	M10x11	-	10	M6x12	M6x8	P6	12	6.6	13.8	44.2	41	172.5	366	9650	10850	10850	3200	10000	LRR 45MXL

1. N₂ = Injecting holes
2. N₃ = O-ring size for lubrication from above
3. N₂, N₃ will be sealed before shipment, please open it when first using the product.

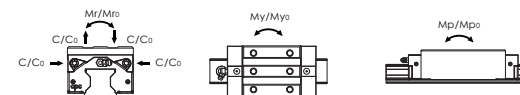

The measured value is the dynamic load rating value with ball chain C_{Cage}. The above static load rating and the static moment are calculated according to the ISO 14728 standard.

Dimensions Table

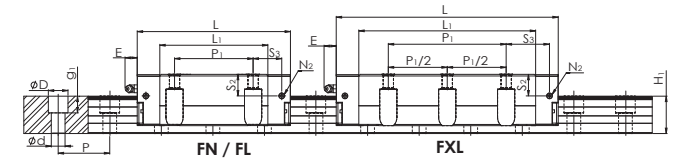
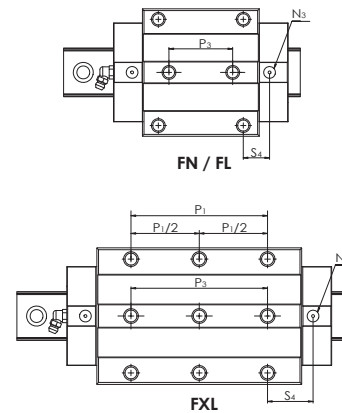
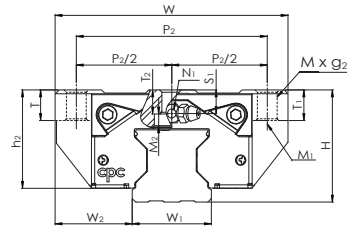
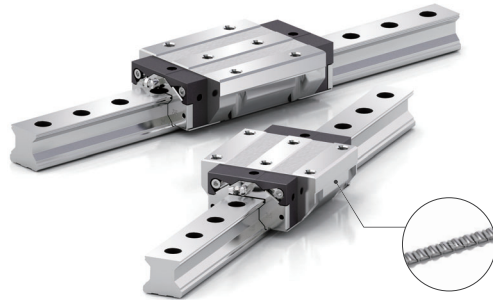

HRR FN/FL/FXL...C Series (Ball chain type)

Model Code	Mounting Dimensions		Rail Dimensions(mm)				Block Dimensions(mm)											Block Dimensions(mm)				Load Capacities (KN)		Static Moment (Nm)			Weight		Model Code								
	H	W ₂	W ₁	H ₁	P	D _x × D _y × G ₁	W	L	L ₁	h ₂	P ₁	P _{1/2}	P ₂	P _{2/2}	P ₃	M × G ₂	M ₁	M ₂	T	T ₁	T ₂	N ₁	N ₂	N ₃	E	S ₁	S ₂	S ₃		S ₄	C _{cage} 100km	C ₀	M _{r0}	M _{p0}	M _{y0}	Block(g)	Rail(g/m)
HRR 35FN	48	33	34	31	40	14x9x17	100	122	84	42	62	-	82	41	52	M10x13	M8	5	13	13	10.2	M6x12	M6x8	P5	12	10	16.4	19	19	71.3	133	2350	1710	1710	1700	5740	HRR 35FN
HRR 35FL	48	33	34	31	40	14x9x17	100	147.5	109.5	42	62	-	82	41	52	M10x13	M8	5	13	13	10.2	M6x12	M6x8	P5	12	10	16.4	31.7	31.7	86.1	175	3133	2881	2881	2400	5740	HRR 35FL
HRR 35FXL	48	33	34	31	40	14x9x17	100	177.5	139.5	42	100	50	82	41	100	M10x13	M8	5	13	13	10.2	M6x12	M6x8	P5	12	10	16.4	27.7	27.7	102.5	224	4047	4695	4695	3100	5740	HRR 35FXL
HRR 45FN	60	37.5	45	38	52.5	20x14x17	120	156	110	52	80	-	100	50	60	M12x15	M10	6	15	15	14.8	M6x12	M6x8	P6	12	14.6	21.8	29.2	26	120	222	5750	4050	4050	3600	10000	HRR 45FN
HRR 45FL	60	37.5	45	38	52.5	20x14x17	120	191	145	52	80	-	100	50	60	M12x15	M10	6	15	15	14.8	M6x12	M6x8	P6	12	14.6	21.8	46.7	43.5	147.5	288	7550	6900	6900	4700	10000	HRR 45FL
HRR 45FXL	60	37.5	45	38	52.5	20x14x17	120	226	180	52	120	60	100	50	120	M12x15	M10	6	15	15	14.8	M6x12	M6x8	P6	12	14.6	21.8	44.2	41	172.5	366	9650	10850	10850	5750	10000	HRR 45FXL

LRR FN/FL/FXL...C Series (Ball chain type)

LRR 35FN	44	33	34	31	40	14x9x17	100	122	84	38	62	-	82	41	52	M10x9	M8	5	9	13	6.7	M6x12	M6x8	P5	12	6	12.4	19	19	71.3	133	2350	1710	1710	1550	5740	LRR 35FN
LRR 35FL	44	33	34	31	40	14x9x17	100	147.5	109.5	38	62	-	82	41	52	M10x9	M8	5	9	13	6.7	M6x12	M6x8	P5	12	6	12.4	31.7	31.7	86.1	175	3133	2881	2881	2200	5740	LRR 35FL
LRR 35FXL	44	33	34	31	40	14x9x17	100	177.5	139.5	38	100	50	82	41	100	M10x9	M8	5	9	13	6.7	M6x12	M6x8	P5	12	6	12.4	27.7	27.7	102.5	224	4047	4695	4695	2800	5740	LRR 35FXL
LRR 45FN	52	37.5	45	38	52.5	20x14x17	120	156	110	44	80	-	100	50	60	M12x15	M10	6	10	15	7.3	M6x12	M6x8	P6	12	6.6	13.8	29.2	26	120	222	5750	4050	4050	2900	10000	LRR 45FN
LRR 45FL	52	37.5	45	38	52.5	20x14x17	120	191	145	44	80	-	100	50	60	M12x15	M10	6	10	15	7.3	M6x12	M6x8	P6	12	6.6	13.8	46.7	43.5	147.5	288	7550	6900	6900	3800	10000	LRR 45FL
LRR 45FXL	52	37.5	45	38	52.5	20x14x17	120	226	180	44	120	60	100	50	120	M12x15	M10	6	10	15	7.3	M6x12	M6x8	P6	12	6.6	13.8	44.2	41	172.5	366	9650	10850	10850	4500	10000	LRR 45FXL

- N₂ = Injecting holes
- N₃ = O-ring size for lubrication from above
- N₂, N₃ will be sealed before shipment, please open it when first using the product.
- M_xG², M₁: Screw size based on ISO 4762-12.9
- M₂ abdomen countersunk head screw size according to DIN 7984-8.8

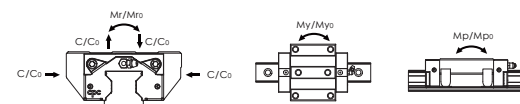

The measured value is the dynamic load rating value with ball chain C_{cage}. The above static load rating and the static moment are calculated according to the ISO 14728 standard.

Nipple Option

Grease nipple/ Oil piping joint

OB-M3-M6	OA-M3-D4	OA-M6-M8	OA-M6-PT1/8	
OA-M6-G1/8	OB-M6-M8	OB-M6-PT1/8	OA-PT1/8-M8	
Ø 6 Oil hole grease injector available	Ø 4 Oil hole grease injector available	Ø 4 Oil hole grease injector available	Ø 4 Oil hole grease injector available	
OA-PT1/8-PT1/8	OA-PT1/8-G1/8	OB-PT1/8-M8	OB-PT1/8-PT1/8	
	Ø 6 Oil hole grease injector available	Ø 4 Oil hole grease injector available		

- The L type nipple is for both ball bearing and roller type external seals (SN)

- The XL type nipple is for the roller type external seal (SN)

Note: in case of need for customization or special requirements, please contact **cpc**

B-M6-XL	OA-M6-M8-L	OA-M6-PT1/8-L	OA-M6-G1/8-L	
OB-M6-M8-L	OB-M6-PT1/8-L	B-PT1/8-L	OA-M6-M8-XL	
Ø 4 Oil hole grease injector available	Ø 4 Oil hole grease injector available	Ø 4 Oil hole grease injector available	Ø 4 Oil hole grease injector available	
OA-M6-PT1/8-XL	OA-M6-G1/8-XL	OB-M6-M8-XL	OB-M6-PT1/8-XL	
	Ø 6 Oil hole grease injector available	Ø 4 Oil hole grease injector available		

Lubrication Kit and Grease Gun

The **cpc** Lubrication Unit is a supply nozzle with 3 different sizes of nozzle adaptors. These nozzle adaptors are suitable for differently sized grease nipples on different sized linear blocks.



Nipple Option

Type	Nipple Size		Nipple Type			
	Section	Side	Standard			
Boil	ARC15	HRC15	-	M3	M3	A-M3
	ARC20	HRC20	-	M3	M3	B-M3
	ARC25	HRC25	ERC25	M6	M3	A/B-M6
	ARC30	HRC30	-	M6	M6	A/B-M6
	ARC35	HRC35	-	M6	M6	A/B-M6
	ARC45	HRC45	-	PT1/8	M6	B-PT1/8
Push	ARR35	HRR35	LRR35	M6	M6	A/B-M6
	ARR45	HRR45	LRR45	M6	M6	A/B-M6

GP-PT1/8-01 Lubrication Kit

The Lubrication Kit comes equipped with a supply nozzle (GT-1/8-M5) and three kinds of different nozzle adaptors (GH-M5-MR, GH-M5-06, GH-M5-08). The supply nozzle can be mounted on the main body of the common manual or pneumatic grease gun with PT1/8 tapped connectors widely available on the market.

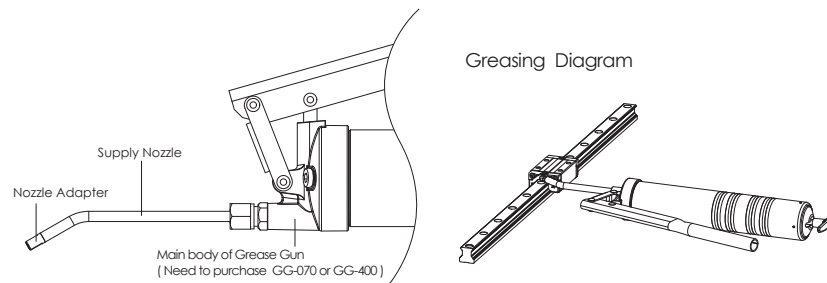

Supply Nozzle

Type	Dimension
GT-PT1/8-M5	

Nozzle Adapter

Unit: mm

Type	Dimension	Grease Nipple
GH-M5-MR		MR series Miniature linear guide size MR-15M \ MR-15W MR-12M \ MR-12W
GH-M5-06		A-M3 A-M3X
		B-M3 B-M3X
GH-M5-08		A-M6 A-M6-L A-M6-XL
		B-M6 B-M6-L B-M6-XL
		B-PT1/8 B-PT1/8X

Main body of Grease Gun

Option for the main body of the Grease Gun: GG-070 for 70g volume grease pack and GG-400 for 400g volume grease pack.

Unit: mm

Type	Dimension	Feature
GG-070		<ol style="list-style-type: none"> 1. Pressure: 27Mpa 2. Output Volume: 0.5~0.7 c.c/stroke 3. Grease: Suitable for 70g volume grease pack or bulk loading
GG-400		<ol style="list-style-type: none"> 1. Pressure: 62Mpa 2. Output Volume: 1.0~1.2 c.c/stroke 3. Grease: Suitable for 400g volume grease pack or bulk loading

cpc AR/HR Z Series Lubrication Storage Pad Testing Report

A linear guide is a category of rolling guidance systems. By using unlimited recirculating stainless steel balls that operate between the raceways of the rail and the runner block, the carriage achieves high precision and low friction linear movement. If the linear guides do not have sufficient lubrication, rolling friction will increase, causing wear and shortened linear guide lifespan.

cpc has added and embedded PU lubrication storage pads to prolong the life of the linear guide; the pads directly contact and lubricate the rolling balls. This design supplies sufficient lubrication even in short stroke operations.

cpc's design, due to the embedded pads absorption and retention capabilities, results in a product that features a long operation life and long-term lubrication.

Following are the results of cpc's in-house testing.

AR15 Lubrication Storage Pad Testing Data

Tested products: AR15 blocks with lubrication storage pads, 8 pieces, and AR15 rails, N accuracy grade, 1500mm Length, 4 pieces

Testing condition	
Rating load capacities(each Block)	1.8KN(C=9KN · C0=17.5KN)
Stroke	0.96m
Max running speed	1m/s
Lubricant	DAPHNE SUPER MULTI 68 [Viscosity64.32 CST 400C]
Lubrication period	No lubrication added during testing period

Testing equipment

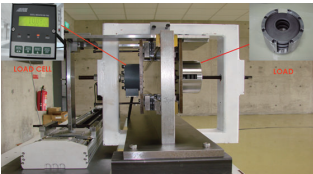

Testing result

Test results at inspection intervals

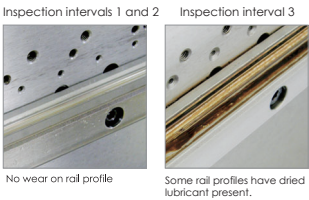
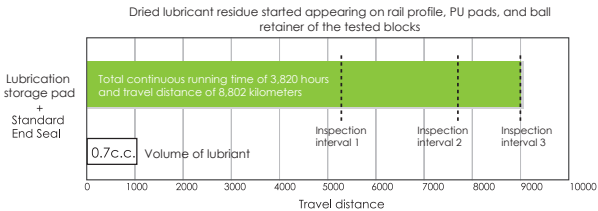

Inspection intervals 1 and 2: Lubrication Maintained

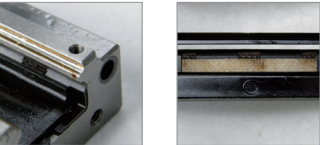

- Upward lubrication storage pads in good condition.
- Downward lubrication storage pads in good condition.
- Lubricant supply in good condition.
- Lubricant supply in good condition.
- No wear on the running profile of the rail.

Inspection interval 3: Lubricant residue

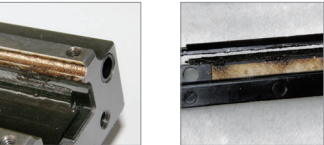

- Dried lubricant residue and breakage on the upward lubrication storage pads
- Dried lubricant residue and breakage on the downward lubrication storage pads.

Plastic parts and end seal in good condition

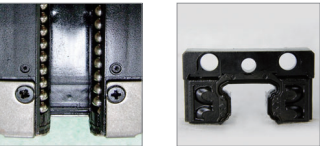

Plastic parts in good condition End seal in good condition

Test Summary

Total continuous running time of 3820 hours and travel distance of 8802 kilometers. Out of eight test blocks, dried lubricant residue appeared on 2 blocks and 1 rail. Dried lubricant residue is indicative of a need for relubrication and thus lengthens the operational life of the linear guide.

Linear Guide Service Life Calculation and Model Selection

Company /		Date (DD/MM/YEAR) /	
Address /		Tel /	
Contact /	Department /	Machine Model /	
Application(Axial) /	Amount required per Machines /	Sample Required Date (DD/MM/YEAR)/	
Application Drawing Provided? <input type="checkbox"/> Yes <input type="checkbox"/> No		Production Date (DD/MM/YEAR)/	
Assembly Specification / Way of Assembling			
<input type="checkbox"/> Horizontal <input type="checkbox"/> Vertical <input type="checkbox"/> Wall Hanging <input type="checkbox"/> Hanging on the Ceiling <input type="checkbox"/> Inclined 1(Degree: _____) <input type="checkbox"/> Inclined 2(Degree: _____) <input type="checkbox"/> Others (Please Draw a Sketch Above)			
Rails per Axial	<input type="checkbox"/> I (1) <input type="checkbox"/> II (2) <input type="checkbox"/> III (3) <input type="checkbox"/> Other _____		
Blocks per Rail	<input type="checkbox"/> 1 <input type="checkbox"/> 2 <input type="checkbox"/> 3 <input type="checkbox"/> Other _____		
Distribution of Blocks (mm)	l_{0} : _____ (Distance Between Blocks on the same rail)	l_{1} : _____ (Distance Between Adjacent Blocks on different rails)	
Center of Mass of load(mm)	l_{mx} : _____ l_{my} : _____ l_{mz} : _____		
Mass of Load (kg)	(Please include mounting plate weight)		
Driver Position (mm)	l_{dz} : _____ l_{dy} : _____		
External Force Applying Position (mm)	l_{Fx} : _____ l_{Fy} : _____ l_{Fz} : _____		
Axial Component (N)	F_x : _____ F_y : _____ F_z : _____		
One Rail Per Axial			
Two Rails Per Axial			
Motion Specification			
Drive Mechanism	<input type="checkbox"/> Linear Motor <input type="checkbox"/> Ball Screw <input type="checkbox"/> Pneumatic Cylinder <input type="checkbox"/> Belt <input type="checkbox"/> Hydraulic cylinder <input type="checkbox"/> Rack and Pinion <input type="checkbox"/> Manual <input type="checkbox"/> Other _____		
Specification	Stroke Distance (mm):	Maximum Speed (m/sec):	
	Acceleration (m/sec ²):	Deceleration (m/sec ²):	
	Stroke Time (sec)	Frequency (hr ⁻¹):	
	Daily Operation Time (hr):	Expected Service Life (Year):	
Environment and Lubrication Requirements			
Environment	<input type="checkbox"/> General <input type="checkbox"/> Clean room(Grade/Class _____) <input type="checkbox"/> Vacuum / Low Pressure <input type="checkbox"/> Small Amount of Dust (Substance _____) <input type="checkbox"/> Large Amount of Dust (Substance _____) <input type="checkbox"/> Liquid (Substance _____) <input type="checkbox"/> Special Gas (Substance _____) <input type="checkbox"/> Other _____		
cpc Initial Lubrication	<input type="checkbox"/> Pre-lubricated (Regular Amount) <input type="checkbox"/> Pre-lubricated (Small Amount) <input type="checkbox"/> None <input type="checkbox"/> Other _____		
cpc Initial Antirust Method	<input type="checkbox"/> Apply Antirust Oil On the Surface <input type="checkbox"/> Apply Grease On the Surface <input type="checkbox"/> None <input type="checkbox"/> Other _____		
Customer Initial Lubrication	<input type="checkbox"/> cpc Grease only <input type="checkbox"/> In addition to cpc Grease Inject Customer's Grease (Grease : _____) <input type="checkbox"/> Remove cpc Grease And Inject Customer's Grease (Solvent: _____) (Grease: _____) <input type="checkbox"/> Other _____		
End User Re-lubrication Method	<input type="checkbox"/> Manual <input type="checkbox"/> Central Oiling System <input type="checkbox"/> None <input type="checkbox"/> Other _____		